

NASA SP-6101 (08)

ISSUES IN NASA PROGRAM AND PROJECT MANAGEMENT

edited by

Dr. Edward J. Hoffman

Program Manager

NASA Program / Project Management Initiative



National Aeronautics and Space Administration
Office of Management Systems and Facilities
Scientific and Technical Information Program
Washington, DC 1994

This publication is available from the NASA Center for Aerospace Information,
800 Elkridge Landing Road, Linthicum Heights, MD 21090-2934, (301) 621-0390.

National Aeronautics and
Space Administration
Headquarters
Washington, DC 20546-0001



Reply to Attn of:

FT

Dear Readers,

In order to satisfy the needs of our current readers and properly expand the distribution of *Issues in NASA Program and Project Management*, we would like to hear from you. This publication is printed twice a year and collects current topics and lessons learned in NASA program and project management.

If you no longer want to receive *Issues*, please let us know. If you know of anyone who would like to start receiving *Issues*, please fill in the appropriate area on the back of this page. Also indicate if you are interested in writing an article for a future volume of *Issues*.

Please complete the form on the back and fax to Debbie Johnson at (202) 863-1664 as soon as possible.

Thank you for helping us update our mailing list. If you have any questions, please call Debbie on (202) 554-1403.

Sincerely,

A handwritten signature in black ink that reads "Edward J. Hoffman" with a long horizontal flourish extending to the right.

**Edward J. Hoffman
PPMI Project Manager**

Please continue to send updated volumes of *Issues in NASA Program and Project Management* to my current address.

Name and Address:

Number of copies
of *Issues*, Vol. 8: _____

I would also like a back copy of *Issues*.
(Please circle volume number.)

#1 #2 #3 #4 #5 #6 #7

I am interested in writing an article for
publication. Please contact me at:

() _____

I do not wish to continue
receiving *Issues*. _____

Please send a copy of
Issues, Vol. 8 to:

Please fax this form to Debbie Johnson, TADCORPS, 202/863-1664.

Issues in NASA Program and Project Management

A Collection of Papers on Aerospace Management Issues

National Aeronautics and Space Administration

Winter 1994

PAGE	TITLE	AUTHOR
1	Power Sources for the Galileo and Ulysses Missions DOE's Director of Safety and Nuclear Operations and past manager of Advanced Propulsion Systems in the Transportation Division of OACT shows how a check-and-balance approach met mission requirements for the radioisotope power sources on the Galileo voyage to Jupiter and the Ulysses exploration of the Sun's polar regions.	Gary L. Bennett
11	Managing Requirements After two decades of managing requirements on the Shuttle program, the author, now with Compliance Automation Inc., offers valuable advice on spotting the major problems in requirements management and improving the process through awareness of necessary, verifiable and attainable requirements.	Ivy F. Hooks
19	Program Control on the Tropical Rainfall Measuring Mission The Tropical Rainfall Measuring Mission (TRMM), an integral part of NASA's Mission to Planet Earth, is noted for its comprehensive Project Control System which covers schedules, budgets, change control and risk assessment.	Dorothy J. Pennington & Walt Majerowicz
36	The Project Management Method The head of Business Management Consultants (BMC), which specializes in project management development and training, emphasizes the concepts of customer, ownership, system and teamwork.	Thomas G. Johns
41	Career Development for Project Management The Program/Project Management Initiative (PPMI) team examines career paths for existing project management personnel and makes career recommendations. Job requirements are identified, as well as training and developmental experiences.	Edward J. Hoffman, Dale Crossman, Deborah Duarte & Andrea Lewis
49	Resources for NASA Managers A PPMI Listserv has been created to provide an interface with the NASA project management community, with instructions on how to subscribe to various lists and discussion groups. Plus, book reviews of three new project management handbooks and other selected titles of interest for program and project managers.	William M. Lawbaugh

SP-6101(08) *Issues in NASA Program and Project Management* is eighth in a series from NASA's Program and Project Management Initiative. This series is collected and edited by Dr. Edward J. Hoffman and Dr. William M. Lawbaugh with Francis T. Hoban, editor emeritus. Statements and opinions are those of the authors and do not represent official policy of NASA or the U.S. Government. Useful and enlightening material is welcome, and diversity of ideas is encouraged.

Inquiries should be directed to Dr. Edward Hoffman, Program Manager, Office of Training and Development, Code FT, NASA Headquarters, Washington, D.C. 20546-0001.

Power Sources for the Galileo and Ulysses Missions

by Gary L. Bennett

The Galileo mission to Jupiter and the Ulysses mission to explore the polar regions of the Sun presented a series of technical challenges to the design, development and fabrication of spacecraft power sources. Both spacecraft were designed to fly to Jupiter. Ulysses, which was launched from the Space Shuttle Discovery (STS-41) on October 6, 1990, used the immense Jovian gravity to twist its trajectory out of the plane of the ecliptic and into a polar path around the Sun in February 1992. Launched from the Space Shuttle Atlantis (STS-34) on October 18, 1989, Galileo will arrive in December 1995 to conduct a 20-month exploration in orbit of the largest planet in the solar system.

In selecting a power source for Galileo and Ulysses, several daunting challenges had to be overcome: the solar energy flux at Jupiter is about 25 times less than it is at Earth (making solar power impractical); the temperatures are quite low (~ 130 K); and the radiation belts are very severe. Fortunately, the successful flights of the Pioneer 10 and 11 spacecraft and the Voyager 1 and 2 spacecraft to Jupiter and beyond had shown that radioisotope thermoelectric generators (RTGs) could easily overcome these challenges. (An RTG consists of a radioisotope heat source that provides thermal power from the natural radioactive decay of the radioisotope fuel to a converter that converts the thermal

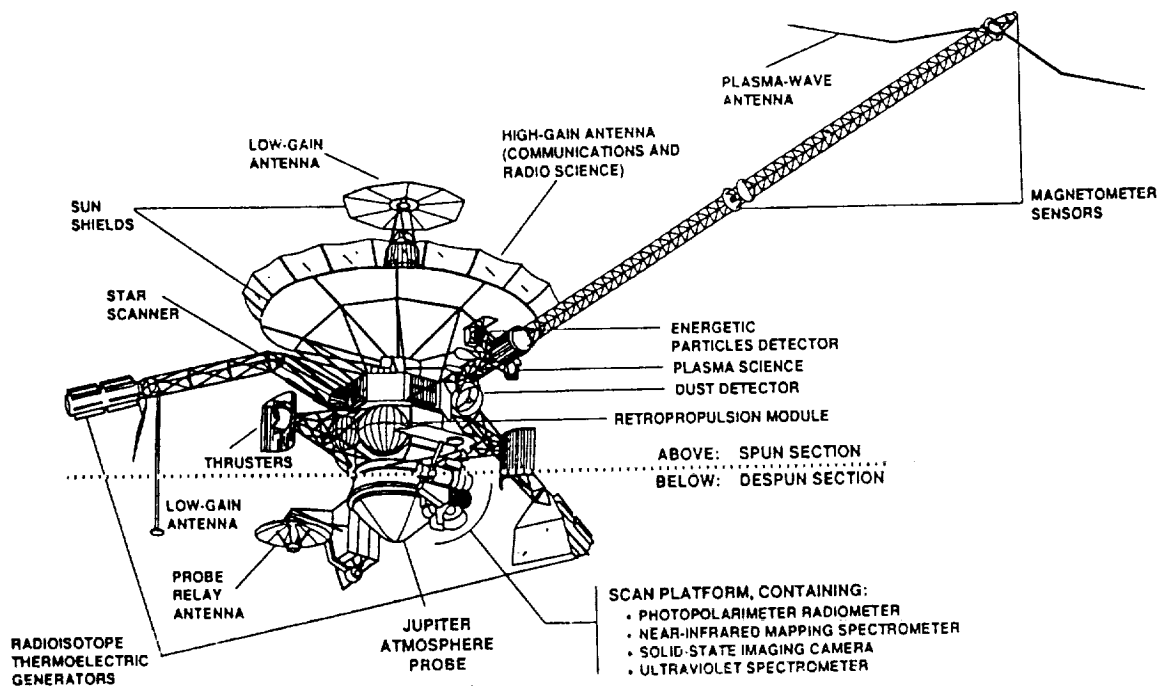

Figure 1. Diagram of the Galileo Orbiter and Probe showing the two general-purpose heat source radioisotope thermoelectric generators (GPHS-RTG) mounted on the two booms. The length of a GPHS-RTG is 113 centimeters (about 45 inches). Galileo is a NASA spacecraft mission to Jupiter, designed to study the planet's atmosphere, satellites and surrounding magnetosphere. Fully loaded with rocket fuel, the Orbiter has a mass of about 2400 kilograms (weight of about 5230 pounds). The Probe, which is designed to enter the atmosphere of Jupiter, has a mass of 340 kilograms (weight of about 750 pounds).

power into electric power by means of a number of solid-state thermoelectric elements.)

After some design changes dictated by the failure of a competing thermoelectric technology and by modified user requirements, both missions settled on a common but then unbuilt power source known as the general-purpose heat source RTG or GPHS-RTG. Performance requirements for the GPHS-RTG were dictated by the spacecraft requirements and the launch vehicles (Space Shuttle originally with Centaur upper stage). The principal requirements were levied on power (at launch, at beginning of mission and at end of mission); structure (ability to withstand launch vibrations and pyrotechnic shock); magnetic field strength (low enough to avoid interfering with the science instruments); mass properties (a low mass was desired and the center of mass was tightly controlled because of spacecraft balance concerns—particularly in the case of Ulysses, which has the GPHS-RTG mounted directly on the side); pressurization (ability to hold a cover gas during ground operations); nuclear radiation (as low as practical); and great functional attributes.

In outward appearance, the GPHS-RTG is basically a cylinder of 42.2 centimeters across the fins and 114 centimeters in length with a mass of about 56 kilograms that provides about 300 watts of electrical power at the time of assembly. As such it is the largest, most powerful RTG ever flown. The Galileo spacecraft has two GPHS-RTGs and the Ulysses spacecraft has one GPHS-RTG [Bennett *et al.* 1986 and Schock *et al.* 1979].

The overall mission schedule impacted the GPHS-RTG program in a number of ways. Originally Ulysses was to be a two-spacecraft mission called the International

Solar-Polar Mission; budget considerations forced NASA to drop its spacecraft, which led to the cancellation of the requirement for one of the GPHS-RTGs. Then the Galileo spacecraft switched from a Voyager-class RTG to the GPHS-RTG, requiring a net gain of one GPHS-RTG to be produced plus a common spare that had to be compatible with two spacecraft that operated at different voltages.

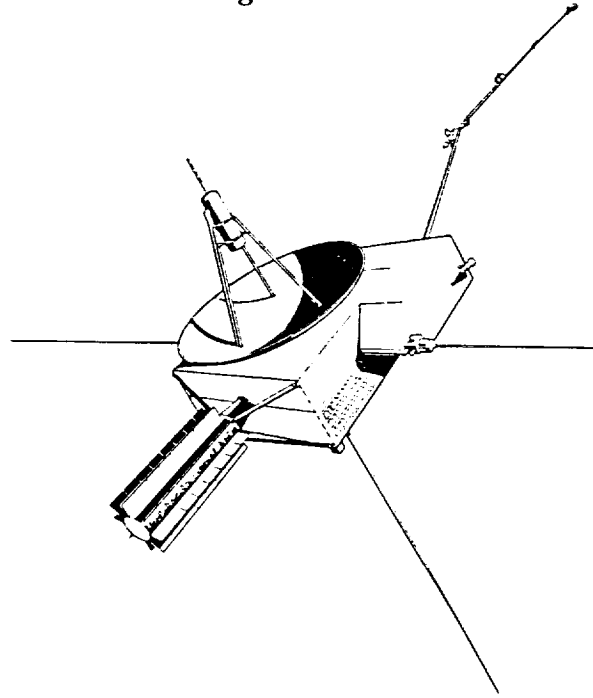

Figure 2. Diagram of the Ulysses spacecraft showing the general-purpose heat source radioisotope thermoelectric generator (GPHS-RTG) mounted on the side. Ulysses is a European Space Agency (ESA) spacecraft mission that was launched by NASA and has some U.S. experiments designed to study the polar regions of the Sun.

The biggest impacts were the launch dates and launch vehicles. Both kept shifting. While launch dates obviously drive delivery schedules, the launch vehicle drives the details of the design. All of these changes and the tight schedules (given the fixed budgets) contributed to a very tense focusing of the program. Fortunately, there was an early agreement on the basic requirements for the GPHS-RTG which allowed some stability—at least in that area!

A number of technical issues were confronted early in the program and successfully overcome through focused team efforts. The following sections describe some of these issues, followed by some personal observations on the process and lessons learned.

■ Technical Issues

The following subsections provide a general summary of some of the major technical issues encountered during the GPHS-RTG program.

Restarting Thermoelectric Production. The thermoelectric elements used in the GPHS-RTGs were of the same basic design as the thermoelectric elements in use on the Voyager power sources. However, during the production campaign for the Voyager program, the thermoelectric elements

had been manufactured by what was then the RCA Corporation. After the completion of that program, RCA ceased its thermoelectric activities, so when the GPHS-RTG program began, the system contractor, General Electric Company (GE) [later Martin Marietta Astro Space], had to establish its own thermoelectric production line.

Small modules consisting of 18 thermoelectric elements each were manufactured and put on test to evaluate the GE product and to determine if GE had been able to duplicate the RCA product. Differences were uncovered that led to the formation of an investigative team of representatives from GE and several Department of Energy (DOE) support contractors and laboratories. The team reviewed the process and product requirements in detail and uncovered some material deficiencies that were quickly corrected.

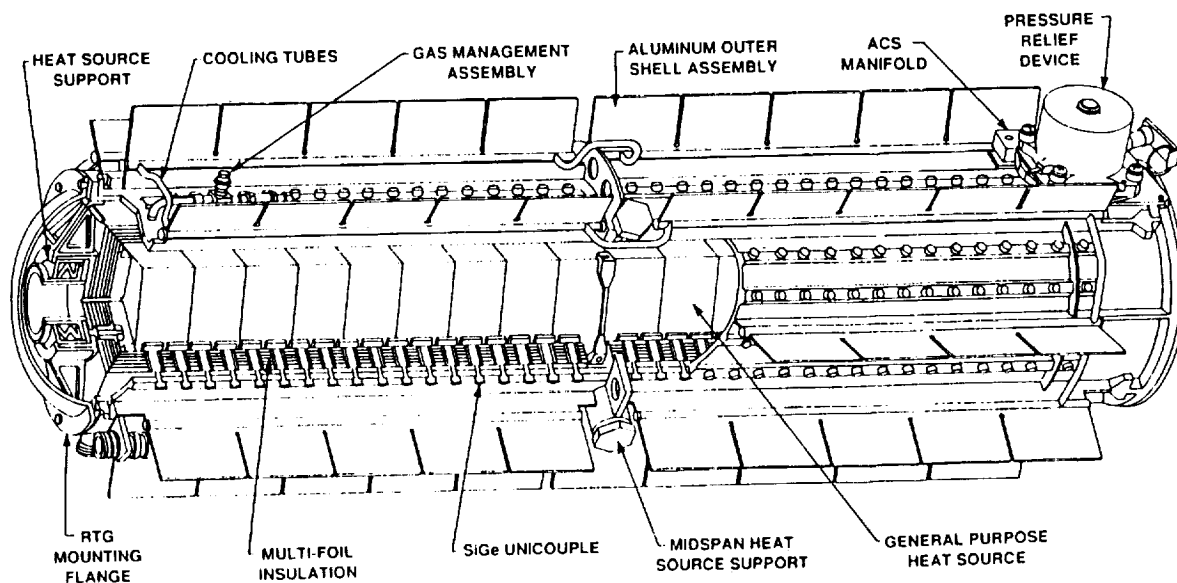

Figure 3. Cutaway drawing of the general-purpose heat source radioisotope thermoelectric generator (GPHS-RTG). The GPHS-RTG consists of two major components: the general purpose heat source (GPHS) and the converter which converts the thermal power generated in the GPHS into electrical power by means of 572 thermoelectric elements called "unicouples." The overall diameter of the GPHS-RTG with fins is 42.2 centimeters (about 16.6 inches). The mass of the GPHS-RTG is about 55.9 kilograms (weight of about 123 pounds). The GPHS-RTG produces over 300 watts of electrical power at the time of assembly. The GPHS-RTG has no moving parts and should provide power for over 20 years after launch.

Perhaps more important was the discovery that actual RCA practices had gone beyond documented specification and process requirements, which led to the explicit written incorporation of these practices along with more detailed instructions, tighter limits, control of more parameters and more detailed descriptions and control of the facility conditions. Facility changes and improved training were completed and a real-time trend analysis system was implemented to record and track key parameters, enabling prompt consideration of process deviations [GE 1991].

Developing a New Radioisotope Heat Source. The radioisotope heat source that powered the GPHS-RTG was a new design that had improved safety features designed to immobilize the plutonia fuel under all credible accident scenarios, including impact on Earth following a postulated atmospheric reentry from space [Snow & Zocher 1978, Snow *et al.* 1978, and Schock 1980].

Production of the radioisotope heat source components ran into a common problem: every time a component moved from the laboratory to production, defects were discovered. In each case, inter-laboratory teams were established to discover the cause of the defects.

Developing the Assembly and Testing Facility. The GPHS-RTG program was operationally conducted in a new way: a DOE laboratory instead of the system contractor had responsibility for the assembly and testing of the power sources [Amos and Goebel 1992]. In order to accomplish this transition in the shortest possible time and ensure the safety of the RTGs, a team comprised of representatives from the system contractor (GE), the heat source laboratory (DOE's Mound Plant) and other involved contractors and laboratories was employed to work the design, procedures and training in real-time. The use of practice hardware, detailed procedures, real-time check-

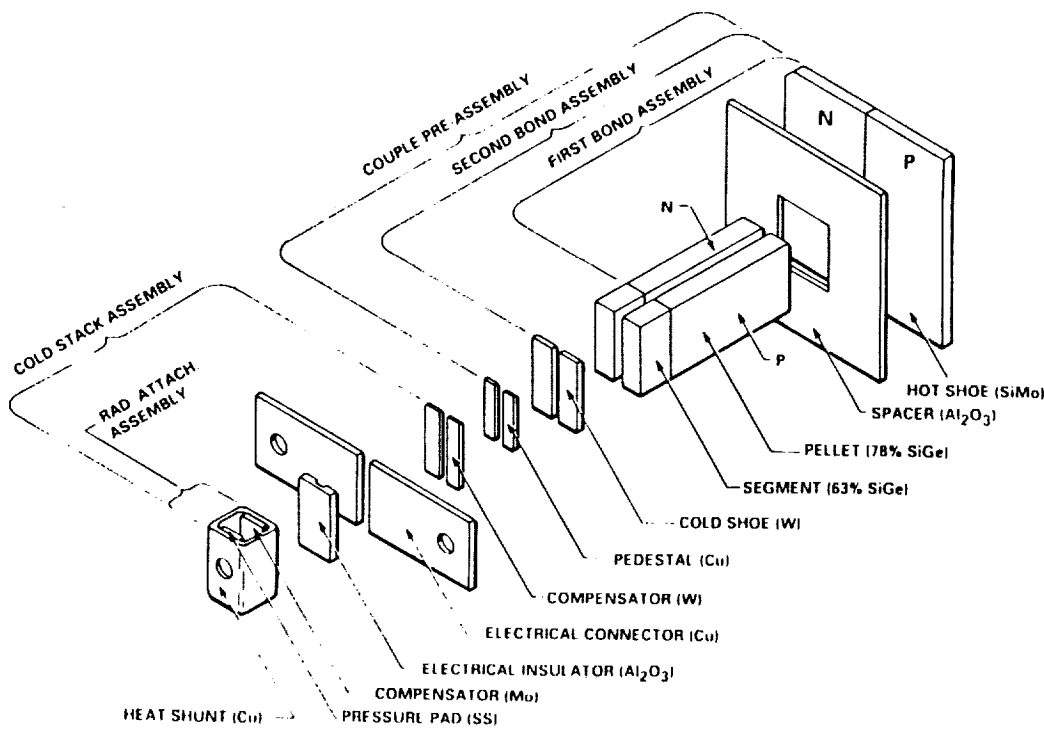

Figure 4. An exploded view of the silicon-germanium unicouple (thermoelectric element). 572 of these unicouples are used in each GPHS-RTG. The unicouple length is 3.11 centimeters and the hot shoe measures almost 2.3 centimeters by 2.3 centimeters. The hot shoe operating temperature is about 1305 K.

ing, and constant training allowed the successful completion of the Galileo and Ulysses power sources. One innovation in the assembly and testing operation was to use a team of knowledgeable people to examine the next steps in a process just before they were to be completed to ensure that nothing in the process, tooling or facilities could damage the RTG. In effect, this was a sort of "advance quality assurance."

■ A Unique Management Approach

The GPHS-RTG program involved a limited "production run" within a tight schedule and budget which required each power source to meet specifications—there was no extra hardware or time for mistakes. Success mainly was due to well-defined objectives with real-time problem solving and a minimum of bureaucratic interference. The GPHS-RTG program was spared the excesses of outside advice and oversight that seem to plague most government programs today. The government program office had full authority and responsibility to manage the program within the budgetary and schedular constraints.

The GPHS-RTG program was managed from a small, proactive headquarters-level government program/project office that numbered at most about 12 people, including two secretaries and several managers who had other responsibilities. This office was totally responsible for the program, including the system, heat source, safety, reliability and quality assurance, and technology, which spanned four contractors and seven government laboratories (totaling over 300 people during the different program phases). All contracting and budgeting were done through headquarters, and the laboratory program guidance was issued from headquarters. A program with as many organizations as the GPHS-RTG program had cannot delegate responsibility

to the field and still expect the program to come together. In essence the GPHS-RTG program was conducted with centralized control and decentralized execution.

Some key advice from the government program office's quality assurance program requirements includes making sure that [Sommer 1982]:

- Requirements are clear and unambiguous.
- Design requirements are adequately specified.
- The design is compatible with fabrication, nondestructive testing, inspection capabilities, and that the fabrication process is adequate to yield the necessary quality hardware as defined in the contract or program guidance.
- The design lends itself to testing at various levels of assembly and the testing process is adequate to yield the required information without degradation of hardware quality.
- The design lends itself to assembly, operations, storage and shipment.
- Parts, materials and processes are selected on the basis of proven experience or qualification for the intended use.
- Cleanliness and contamination specifications for materials and processes are consistent with design requirements.
- Safety requirements are specified and procedures are established to ensure their adequate implementation.

An interagency agreement between NASA and DOE defined the roles and responsibilities for the two agencies in the GPHS-RTG

program. Top-level interface specifications and drawings were jointly signed off by DOE and the NASA project office at the Jet Propulsion Laboratory (JPL). The top-level requirements were in turn translated into contractual requirements for GE and into program guidance to the national laboratories. All requirements were worked with a view toward achieving mutual agreement between the involved organizations. GE was the system contractor and DOE's Mound Plant, working under the system requirements, was responsible for all of the heat source activities.

To meet the schedule meant turning on everything at once (a technique now often referred to as "simultaneous engineering," "concurrent engineering" or "integrated product development"). Reliability, quality assurance and safety were incorporated from the beginning. This parallel approach meant constant attention to the technical and programmatic interfaces. The program office personnel met regularly with the contractors and laboratories, typically on a monthly basis and more often as the situation dictated. Program office personnel served on the major teams that were established to work the various problems. The customer (JPL) was also regularly involved in the program. In the beginning of the heat source production campaign, monthly meetings of the key organizations permitted a number of interface issues to be worked quickly between the involved parties. Throughout the program, the participants engaged in regular, informal contact and discussion. Hardware, tooling and facilities were visited on a regular basis. On-site representatives were used as needed (for example, GE had one or more representatives at Mound; DOE and its quality assurance laboratory had representatives at GE; and on occasion, Mound personnel worked directly with personnel at the other heat source laboratories). Problems were

not allowed to fester. In order to meet the schedule, each problem had to be addressed as it occurred.

The program was managed with a strong focus on schedule—the overriding objective was to deliver the requisite RTGs to specification on time and within budget. There were real-time inspections, materials review boards (MRBs), failure review boards (FRBs), and process reviews. The quality control inspectors were on the line doing their work in real time. Faxes and telephone calls were used to expedite the approval process—the schedule did not permit the bureaucratic practice of letting the mail room handle the distribution of actions.

One of the outstanding resources of the GPHS-RTG program was the heritage of experienced personnel (the "RTG culture") at most of the facilities. Most of the key people knew each other and understood their capabilities and roles. These people were in the program for the "long haul" and they had a positive "can do" attitude. All of the organizations had a history of involvement in RTG programs. As a result, the various organizations were able to work as a team, forming task forces as needed to solve problems. Responsibilities, accountability and control were well defined. The government program office also maintained a check-and-balance approach as needed through the judicious use of its own people and independent organizations.

The government program office used an operations analysis to assess the facilities, procedures and training at each site before the RTG or heat source arrived there. The operations analysis team looked at the various environments to which the RTG hardware might be exposed. The team included representatives from the other organizations involved.

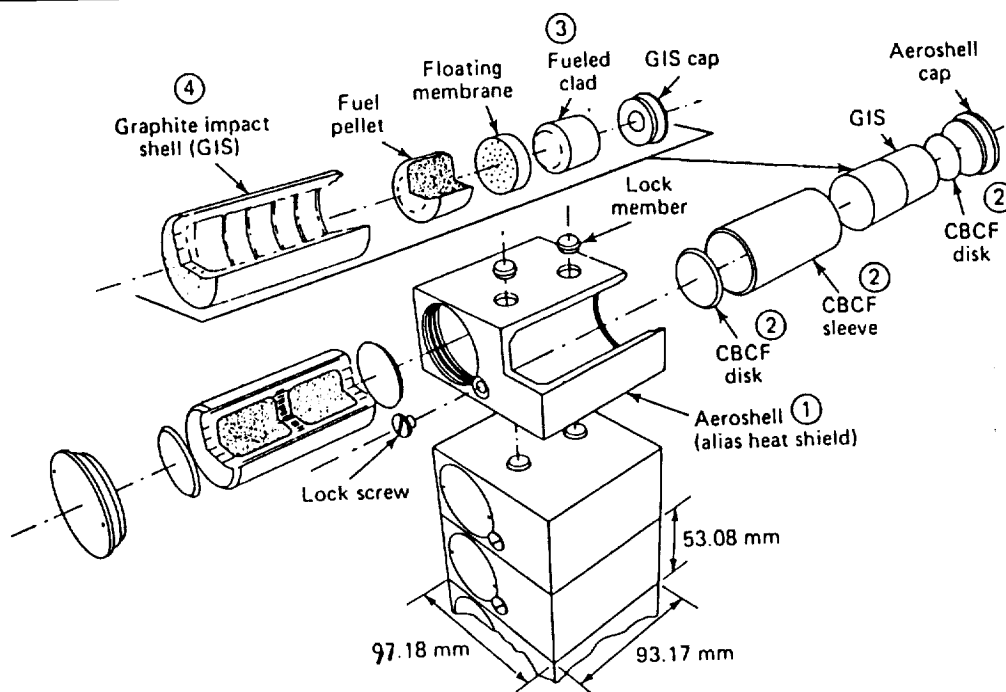

Figure 5. Cutaway view of the general-purpose heat source (GPHS) module components and assemblies. Eighteen of these modules are in each GPHS-RTG.

Readiness reviews were conducted at each step in the process to ensure that documents were complete, that the requirements and test plan were complete, that the incoming articles were as built (identification and verification of the configuration), and that the test equipment was calibrated. Tooling was under control. Data packages were prepared to document the hardware and how it was built and tested. Finally, before the GPHS-RTGs were shipped to the Kennedy Space Center (KSC), a formal flight readiness review was conducted; it covered the contractual requirements and the flight worthiness of the hardware and checked to ensure that everything was in place for the shipment.

The government program office controlled the Class I changes to specifications and procedures; that is, changes dealing with safety, performance, reliability, interchangeability, qualification status and interface characteristics ("form, fit, function, and safety"). The government had representatives on the MRBs and the FRBs.

One of the lessons from past RTG programs was the need for constant attention to detail. Everything must be documented and tracked. Full documentation is just good engineering and scientific sense because it facilitates investigations into problems that may come up. Relying on specifications is no guarantee of the quality of the final product—the processes must be under strict control, too. Like its predecessor programs, the GPHS-RTG program began with component testing and moved on to subsystem and full-up system testing before the flight hardware was built and flown. (It is worth noting that even while today's quality programs emphasize one-time inspection, the GPHS-RTG program did uncover cases where receiving inspections caught problems not identified in the sending inspection.)

To meet the schedule meant freezing the design as early as possible and sticking to that design, unless problems necessitated consideration of a change. Every program is faced with the better idea or technology

that comes along after the design is frozen, but as long as the existing design meets the design requirements, changes should be avoided because they can cause enormous confusion and delays. The old adage, "better is the enemy of good enough," is true.

In addition to sticking to the frozen design, the program must also stick to the test program and avoid unnecessary tests. The GPHS-RTG program was a flight program, not a research program.

Finally, it is important to return to the matter of people. Large, complex programs cannot be run by committee or diffuse management structures. To paraphrase Charles Sheffield, large projects have been built in the past and in their day they, too, challenged the state of the art. "The problems that they ran into were often horrendous and all different, but the really successful. . . have had one thing in common: associated with each, obsessed by each, you will find a single individual. . . The Manhattan Project is a prime example of a group effort. There were dozens of scientists working on the atomic bomb whom history has judged as geniuses. But at the top, following everything at a level of detail that even his fellow workers found mind-boggling, was one man: Robert Oppenheimer. Through the 1960s, when NASA had just nine years to put a human on the Moon, a handful of staff—Wernher von Braun, George Mueller, and George Low—poked into everything and tracked everything." [Sheffield 1991.]

Fortunately for the GPHS-RTG program, there were also a handful of people who checked into and tracked everything. These people were obsessed with the success of the GPHS-RTG program and they were personally committed for the duration of the program.

■ Lessons Learned

From the foregoing and the author's experiences in managing the safety and nuclear operations elements of the GPHS-RTG program, the following lessons were learned:

- Dedicated, trained people working as a team are the first key to success. All of the organizations involved in the program need to understand their individual roles and responsibilities. Accountability is crucial, but with accountability must go the authority and the resources to do the job.
- The design requirements should be fixed early in the program and the principal ones should not be changed except as required by the exigency of the program and then only through a formal, disciplined process of reviews and approvals.
- A central program office should have complete authority and responsibility to manage the program. There must be a centralized decision process for the "form, fit, function, safety" of the program. Outside reviews and "help" must be minimized and the budget should match the requirements and schedule.
- Training is essential in every aspect of the program. Technicians should be formally qualified (preferably with written certificates) for each process they are asked to perform. The training must be realistic and current, and done with realistic practice hardware.
- The procedures must be sufficiently detailed to cover every step of the process. Nothing in the procedures should be left to chance or interpretation. (The author found one case in which a procedure called for a component to be "washed"

but the washing was not specified. One technician did it one way; another technician did it a different way. Needless to say, product differences were found.)

- The facilities must be clean, orderly, worker friendly and suitable for the tasks. (In checking into a problem with one metal alloy, the author found the metal pressing was being done in an old building with a hole in the roof—and the hole was above the location where the material was being worked!) It helps immensely if the facilities, equipment and tools are dedicated to the program and kept under the control of the program. If not, there must be formal reviews each time before the facilities and equipment are used to ensure that they are ready for the process. (In another program the author worked on, some technicians working on a second program borrowed a gas management console, and when it was returned, the valve settings had been changed and no one was informed. The technicians on the first program did not check this and almost destroyed a power source by admitting the wrong gas.)
- The laboratory work done to develop a process or material or component must be done with the same documented rigor as the final production work. Invariably one of the reasons that the production people found problems with a laboratory-developed product was that the laboratory people were not using the same quality control inspection techniques and tools as the production people. Also, there is a tendency in laboratory work not to document the work to the detail necessary to develop production procedures that will yield a reproducible product.
- To meet the schedule, the whole team must operate with a sense of urgency. Paperwork, reviews and approvals must not be allowed to lag. Quality control inspections and review board activities must be done in real time. However, at no time should schedule be the excuse for not producing a quality product that meets the requirements.
- A test philosophy of building and testing hardware through increasing levels of assembly should be employed. For the GPHS-RTG program, the thermoelectric elements were first built and tested, followed by the testing of 18-element modules. Then full-scale engineering units were built and tested for structural, mass properties and electrical tests. After the engineering units had proven the design, a full-scale radioisotope-heated qualification unit was built and tested to qualify the overall RTG design. Finally, the four flight RTGs were assembled and tested. Supporting this test program were engineering analyses, component testing and materials characterizations, and throughout there was a constant attention to detail.
- There must be agreement between the sender/producer and the receiver/user on the inspection procedures and the inspection tools to avoid problems where the producer sends something that passes the producer's inspection only to see it rejected by the user.
- Independent operational analyses and advanced process reviews must be conducted to ensure that personnel and facilities are ready to receive and work on the hardware. With limited hardware, the protection of the product is of paramount importance.

Four flight power sources (three flight RTGs and a common spare) were successfully assembled and tested for use on the Galileo and Ulysses spacecraft. The three GPHS-RTGs in use on the Galileo and Ulysses spacecraft have met all power performance requirements to date [Bennett *et al.* 1994]. In summary, the GPHS-RTG power sources performed as required, were

delivered when required, and were completed within the cost envelope established by NASA and DOE. The GPHS-RTG program was successfully completed largely because of an experienced, dedicated team working under a small program office with focused objectives and no outside interference.

References

- Amos, W. R. and C. J. Goebel. "Assembly of Radioisotope Heat Sources and Thermoelectric Generators for Galileo and Ulysses Missions," in *Space Nuclear Power Systems 1989*, edited by M. S. El-Genk and M. D. Hoover, Orbit Book Company, Malabar, FL, 1992, pp. 25-37.
- Bennett, G. L., J. J. Lombardo, R. J. Hemler and J. R. Peterson (1986). "The General-Purpose Heat Source Radioisotope Thermoelectric Generator: Power for the Galileo and Ulysses Missions," in *Proceedings of the 21st Intersociety Energy Conversion Engineering Conference*, San Diego, CA, August 25-29, 1986, pp. 1999-2011.
- Bennett, G. L., R. J. Hemler and A. Schock (1994). "Development and Use of the Galileo and Ulysses Power Sources," paper IAF-94-R.1.362 prepared for the 45th Congress of the International Astronautical Federation, Jerusalem, Israel, October 9-14, 1994.
- GE (1991). *Final Report for the General Purpose Heat Source-Radioisotope Thermoelectric Generator Program*, GESP-7209, General Electric Company, Philadelphia, PA, February 1, 1991.
- Schock, A., A. Shostak and H. Sookiazian (1979). "Design, Analysis and Optimization of RTG for Solar Polar Mission," in *Proceedings of the 14th Intersociety Energy Conversion Engineering Conference*, Boston, MA, August 5-10, 1979, pp. 1444-1454.
- Schock, A. (1980). "Design Evolution and Verification of the 'General-Purpose Heat Source,'" in *Proceedings of the 15th Intersociety Energy Conversion Engineering Conference*, held in Seattle, WA, August 18-22, 1980, pp. 1032-1042.
- Sheffield, C. (1991). "The Mote in NASA's Eye," *Analog Science Fiction/Science Fact*, October 1991, pp. 79-90.
- Snow, E. C. and R. W. Zocher, (1978). *General-Purpose Heat Source Development, Phase I—Design Requirements*, LA-7385-SR, Los Alamos National Laboratory, Los Alamos, NM.
- Snow, E. C., R. W. Zocher, I. M. Grinberg and L. E. Hulbert (1978). *General-Purpose Heat Source Development, Phase II--Conceptual Designs*, LA-7546-SR, Los Alamos National Laboratory, Los Alamos, NM.
- Sommer, K. G. (1982). *Quality Assurance Program Requirements for Space and Terrestrial Nuclear Power Systems*, OSNP-2, Rev. 0, U.S. Department of Energy, Office of Space Nuclear Projects, Washington, D.C.

Managing Requirements

by Ivy F. Hooks

Several years ago, I called upon an old acquaintance who had recently assumed management of a troubled program. I told him that I would like to help him manage his requirements. He told me that he did not need any help because he had asked the advice of a mutual friend and NASA manager. That advice was: "Just say 'no' to all proposed changes."

This was not necessarily bad advice, it was just not appropriate to this manager's problem. A major problem with the program was that it had very poor requirements that could not be satisfied within budget or schedule. I have no idea what the program manager actually did, but the program has since been canceled.

You may be surprised to learn that you are not really managing requirements. Program managers tend to focus on subjects other than requirements. This occurs because of a bad assumption—the manager assumes that everyone knows how to write requirements, thus the requirements process will take care of itself.

Most program managers have technical backgrounds, and will focus on the non-technical aspects of the program that are new and alien. New program managers know that they do not fully understand budgets, so more attention goes to budgets. Since the program manager's boss will focus on budgets and not on requirements, the program manager places more attention on that which interests the boss.

Most people understand that bad assumptions are traps just waiting to get you, and

this bad assumption—*requirements will take care of themselves*—is no different. This paper examines how this bad assumption can wreak havoc with a program, the types of problems that occur because of this bad assumption, and what NASA program managers can do to improve their requirement management process.

■ Failure to Manage Requirements Affects Programs

If the program requirements are not well understood, there is not much hope for estimating the cost of the program. In today's environment—15% overrun and your program may be canceled—it is foolish to budget incorrectly. But you cannot budget correctly without a good set of requirements.

Werner Gruhl developed a history of NASA programs versus cost overruns (Figure 1). He attributed much of the problem of cost overruns to the failure to define the program properly in Phase A and B so that good cost estimates could be made.

Even with the best cost estimate, many programs will encounter overruns because of changing requirements. This phenomenon is one the aforementioned program manager was trying to avoid. The time to avoid this problem is not in Phase C or D but at the beginning of the program. Therefore, I interpret the Gruhl chart differently. If you have not done a good job in Phase A and B in defining and confining your program, including documenting the requirements, you are going to encounter large numbers of changing requirements and the cost will go up accordingly.

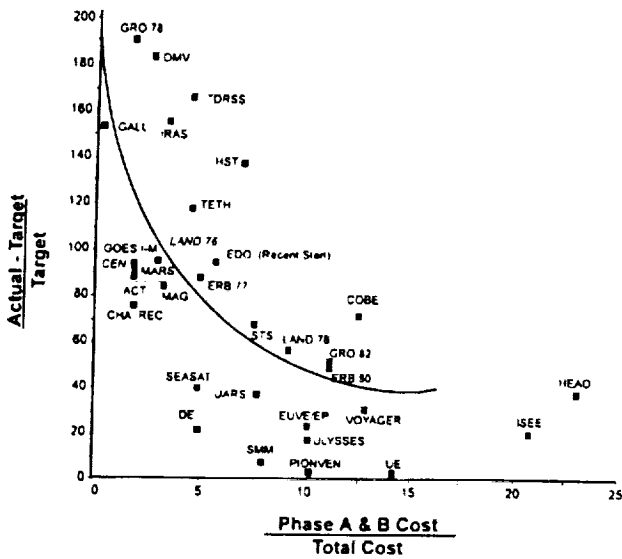

Figure 1. Effect of requirements definition investment on program costs. By Werner M. Gruhl, Chief, Cost and Economic Analysis Branch, NASA Headquarters.

The relationship between program cost and requirements is cyclic (Figure 2). You cannot affect one without affecting the other, but program managers try. Budgets are cut, but the program manager tries to keep the requirements intact. There are some occasions where a design change will save money and all requirements will still be met, but this a rare occurrence.

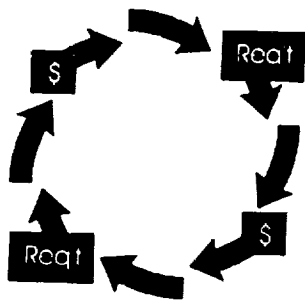

Figure 2. Cyclic effect.

It is almost impossible to change any requirement without affecting the net cost.

Unfortunately, it seems that this is heavily biased in one direction, i.e., any change to a requirement results in an increase in cost. Even when you delete or reduce a requirement, you will encounter some cost—you cannot make a change with paying. Hopefully, deleting or reducing a requirement will result in a net savings.

It seems obvious that requirements drive program costs and that changing requirements are a major driver of cost overruns. Poor requirements contribute to the need for change.

It is important to understand the type of errors that occur in requirements in order to avoid these errors and subsequent changes. An IEEE study (Figure 3) shows types of non-clerical requirement errors. In this study, the ambiguities and inconsistencies make up about 20% of the errors, and omissions account for another 31%. The largest number of errors (49%) were for incorrect facts. Most of the incorrect "facts" that I have encountered come from incorrect assumptions.

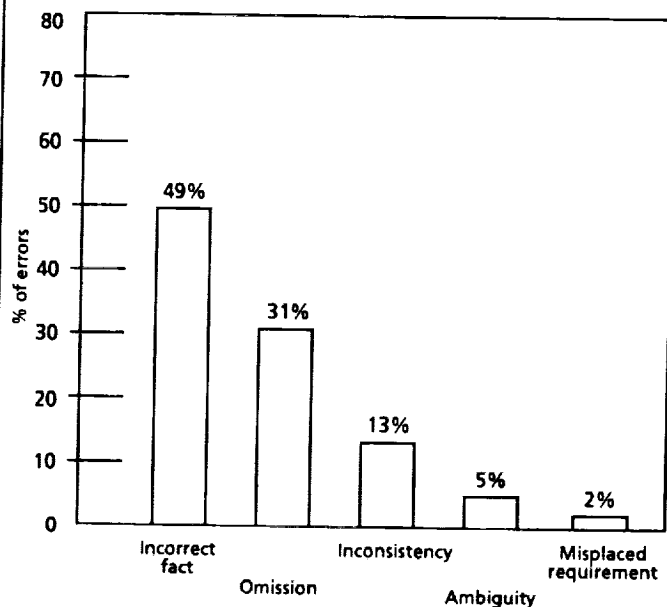

Figure 3. Types of non-clerical requirements errors. 1981 IEEE Computer Society, Inc.

The “cost of assumption error” chart (Figure 4) has been presented by many different companies and organizations over the years. The chart shows the relative cost over the software life cycle to correct an “assumption error.” If identifying and correcting the error during the requirements definition phase cost you \$1.00, it will cost from 40 to 1000 times as much to fix if not identified until the operations phase. The cost to fix the error rises rapidly as you proceed into the life cycle. I suspect that you only need to add a few zeros to the multipliers to reflect the cost for hardware programs.

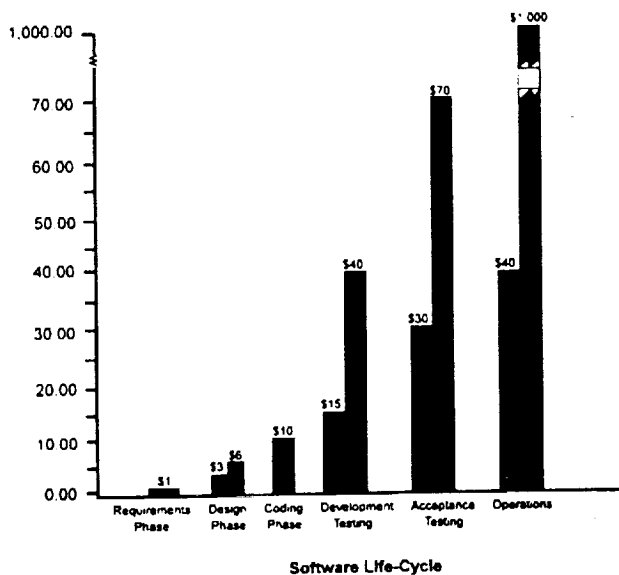

Figure 4. Cost of assumption error in requirements phase. “Extra Time Saves Money,” Warren Kuffel, *Computer Language*, December 1990.

The information in this figure is also applicable to other requirements changes. If you decide to change a requirement at the beginning of the program, the cost will be minimal compared with making a change after you have begun development or when you are in operations.

These two previous figures indicate the importance of controlling all assumptions and all requirements from the beginning of the

program. Gruhl’s chart shows the importance of devoting resources to Phase A and B efforts.

Given the evidence of poor requirements definition and management as the cause of program cost overruns, why do program managers continue to make the same mistakes?

Major Problems in Requirements Management

The major cause of bad requirements is that people do not know how to write requirements. The problem is compounded by a lack of management attention and a poorly defined requirements management process. If the program manager assumes that 1) everyone knows how to write requirements; 2) the requirement definition process is well understood; and 3) the review process will fix any problems, then problems are guaranteed.

1. Everyone does not know how to write requirements. Very few people really understand how to write good requirements. In each of my courses, I ask the class, “How many of you have had to write requirements?” then, “How many of you have had to review or verify someone else’s requirements?” Most respond to one or both questions. Then I ask, “How many of you have been happy about either process?” Rarely does anyone respond to the final question.

The problem is that, while these are very bright people, they sense a lack of management interest, are not provided the information needed to do a good job, and do not have the knowledge to do the job.

Lack of Interest. Writers of requirements can sense a lack of management interest. Emphasis is on schedule—getting a specifi-

cation written so that a procurement can be conducted—not on quality. Most have never seen anyone recognized for doing a good requirements writing job, and none has seen anyone suffer for having done a poor job. Hence, they do the best they can, given limited information, time and guidance. Not surprisingly, the resulting requirements will need to be rewritten many times before the program is complete.

Nearly 1,500 NASA and contractor personnel have been through our Requirements Definition and Management Course. A recurring response to the post-class survey is “my management does not understand this process” and “my manager does not support my doing this work.” This should be a red flag to all NASA managers.

Lack of Information. The NHB 1720.5 requires documentation of the scope of large programs and projects. The program plan is essential for all size programs and projects. Without this information, it is impossible to get good requirements. No one can write good requirements without a clear understanding of the scope of the project, its mission and operational concepts. Each requirements author needs to know the goals, objectives and constraints associated with the program.

In fact, no one can write good requirements in a vacuum. If the program manager does not supply the scope, each individual author will define a scope. Each individual will probably define a unique scope and the resulting requirements will be responsive to a variety of concepts, objectives and constraints. This is an invitation to disaster. NASA has established the process, but it is up to each program and project manager to ensure that the content, quality and timeliness of the program plan supports the requirements development process.

Lack of Knowledge. Engineers at NASA frequently are asked to write, review, design to, or verify requirements very early in their careers. They may not have ever heard the word “requirement” in college. They have an idea of what they are to do, but their ideas and examples of existing requirements may be all wrong. If management is not prepared to mentor and assist these new engineers, they will do their best, but it will not be good enough. Some people with many years of experience do not appreciate the importance of good requirements or what it takes to write good requirements. Some of these people may be trying to mentor, but they also lack the necessary knowledge.

Recently, a division chief was reviewing a report that I had written against a set of system requirements. The report showed the current requirement, explained what was wrong with it, and provided a rewrite. His response was, “I would have thought these current requirements were okay.” He was just being honest, although he lacks the knowledge to help his people. In fact, the lack of sufficient and knowledgeable mentors has affected all levels of NASA personnel.

Only requirements that are necessary, attainable and verifiable should appear in a specification. If the requirement authors are apprised of this and held accountable, there is some chance of creating a valid specification. Each of these attributes is essential to good requirements, and further details are provided later in this paper.

2. The requirement definition process is not well understood. Many view the requirement definition process as only major milestones: release of a specification for the Request for Proposal (RFP) and a System Requirements Review (SRR). The pro-

cess involves many steps to reach the milestones, but these are often ill-defined or not communicated to the team.

A disciplined program manager must assure that the steps are clearly defined and communicated, ample time is allotted, and a qualified team is assembled to ensure a good specification. Otherwise, the result will be a poor specification, tons of Review Item Disposition (RID) forms and more effort in the review than was ever expended in the requirement definition process.

Too many cooks can spoil the broth, especially if each is using a different recipe, i.e., working without a well-defined program plan. Too often, NASA's approach to requirements is to invite everyone to create a wish list, which creates unnecessary, unverifiable and unattainable requirements. To solicit requirements from a large group of people, you must provide them with the program plan and insist that their requirement be responsive to your plan. You must instruct them to justify each requirement, just as you will require them to justify each future change. You must educate them about defining only requirements that are necessary, verifiable and attainable.

You need to use concurrent engineering in defining requirements. This is essential to ensure that all requirements are captured in the initial definition phase, not after design, testing or operations are underway. This means having not only the customer, user and functional area designers involved in the process, but also participants from safety, reliability, manufacturing, test and operations.

Failure to include this cross-disciplinary group in the requirements definition process can result in a system that exceeds costs for manufacturing, is unreliable, and that will cost a fortune to maintain and op-

erate. Too many problems will be found too late in the program life cycle, and the program costs and schedules will overrun significantly, as indicated in Figure 4.

The requirement definition process needs strong, experienced, system-oriented personnel to help elevate detailed engineering discipline requirements to real system requirements. Discipline engineers will tend to write requirements as though for their discipline, resulting in detailed subsystem definition before the system design is done. It is not unusual to see a system specification with requirements that read:

The guidance and navigation subsystem shall . . .

The failure and warning system shall . . .

The communications subsystem shall . . .

These are not system requirements, and they play havoc when a contractor designs your system and develops lower level requirements. A strong systems engineer can assess the real needs and develop system-level requirements from those proposed by discipline engineers.

Requirements defined by scientists also require a good systems engineer to interpret and translate science requirements into engineering requirements. Many NASA Centers handle science requirements, and the subject arises repeatedly in our training classes. The engineers are frustrated in two areas. They see no constraints on the science requirements—they could be simply a wish list. In fact some scientists seem to feel that they are entitled to ask for anything on a NASA program, since they do not have to pay for it. Management must control the science requirements just as rigorously as engineering requirements. Are they necessary? Are they attainable?

The second frustration is one of translating science requirements into engineering requirements. Centers that repeatedly face this challenge need a team of experts to do this job. Scientists know what they want but are often unable to write an appropriate specification. Engineers who understand what the scientist wants and can translate this into a valid and verifiable system requirement are very valuable.

To ensure proper translation, each requirement written in response to a science requirement should clearly document the assumptions made and how the translation was conducted. Then the scientist should be asked to approve the engineering requirement(s) and review the operational concept and implementation before baselining. It is important to select the right team of people and to put in place the right processes with reasonable schedules in order to succeed in the requirements definition phase of the program.

3. The review process cannot fix all problems. If you have produced a very good set of requirements, selected knowledgeable people for the review process and managed the review properly, you will be rewarded with a set of recommendations to improve your program. If you have failed to do any one of these steps, the review process will be a waste of time and money.

The review completion allows you to move into the next phase of the life cycle. But a review of poor documents, no matter how well-conducted, will increase your program risk. You will not have identified all the necessary items and you will be redefining throughout the next phase, leading to increased costs and schedules slips.

Some large NASA programs have recently had more than 7,000 RIDs against a single document. This is inexcusable. First of all,

the document being reviewed was too poor to have been released in the first place. It should have been cleaned up considerably before being allowed out for review. This is clearly a management problem.

Second, there were too many inexperienced reviewers. Managers have told me that they had no control over who reviewed the document. This is ridiculous; this is a program cost and it should be controlled. Many of the reviewers stated that they were expected to write a certain number of RIDs. The reviewers were often inexperienced and so wrote individual RIDs for every editorial comment—these will certainly get the numbers up.

Management should provide instructions for the review. These should include stating that all editorial RIDs can be placed on a single form. You might question why, with grammar and spelling checkers available on all word processors, there are any editorial RIDs at all. All participants in the process should be qualified as having some knowledge in both the process and the program before they are allowed to write RIDs. This may take some effort on the part of management, but not nearly as much effort as struggling through hundreds of useless RIDs.

■ Improving the Requirement Management Process

Steps to improving requirement quality and the requirement management process are straightforward and can be implemented with minimal cost and extraordinary results. The first step is to ensure that a good program plan—containing goals, objectives, constraints, missions and operational concepts—is available to all participants. The second step is to establish a well-defined requirement definition process and to educate the participants to their respon-

sibilities. It is essential that each participant be aware of the characteristics of good requirements: necessary, verifiable, and attainable. Requirement definition must include tests of these characteristics.

Necessary. I once requested that an engineer withdraw a requirement, since it was unnecessary. The engineer said, "No, let my manager take it out if he wants to." Odds are the manager will not catch the problem. Responsibility, authority and accountability must be identified and enforced. Responsibility should be imposed at all levels, but it ultimately rests with the program manager. Every requirement should be clearly understood before the first draft is released, not during CDR.

Each requirement should be examined as rigorously as each change will be examined in the future. The first time a requirement appears, you should treat it as though it were a change that will cost your program a great deal of money. You need to know why the requirement is needed and any assumptions that were made by the author. These are questions you will ask for each change—ask them now. All requirements should be in response to your program plan. If they are not, they may not be necessary.

Attainable. It is a waste of time and money to write unattainable requirements. If the effort is for new technology, then there may be a question about the technical ability to attain the requirement. This can be handled by tracking the requirement as a risk. Unattainable requirements often come into being because the original author does not know what is needed. The Space Station requirements have been through many iterations. Unfortunately, no rationale or justification was captured in the process. As some items are converted

from contract to GFE, it has become apparent that unattainable requirements were written and never caught.

One recent problem requirement affected the use of the Global Positioning Satellite (GPS). The requirement was for an accuracy unattainable by the GPS. When questioned, it was divulged that no one had computed a required value, but an engineer had simply guessed that a certain value was attainable and entered it into the requirements. Management had not questioned the value. The requirement will have to change and someone will need to determine the correct value. Remember Figure 3, in which 49% of the requirements errors were incorrect "facts"?

Many unattainable requirements are technically feasible but still unattainable. You do not need requirements that exceed your budget; even if they are technically feasible, they are unattainable. Unmanaged authors will write requirements for many items that would be "nice to have" but are really unnecessary or unattainable due to budget and schedule constraints. It is the job of program management to prevent this from occurring.

Verifiable. It is hard to believe that there are engineers and managers who do not know that all requirements must be verified. It is important to analyze each requirement in light of how it will be verified as it is written and before it is baselined. This is not the case on all programs. Last year a change request was written for the Space Station Freedom Program to correct or delete over 100 unverifiable requirements from the system specification. One can only wonder how more than 100 unverifiable requirements had remained in the document through so many reviews and scrubs.

A good check against unverifiable requirements is a simple test of word usage. Words and phrases like *maximize, minimize, support, adequate, but not limited to, user friendly, easy, and sufficient* are subjective and thus unverifiable. Verification costs are often a major element of the program cost. Removing unverifiable requirements and specifically addressing how each requirement will be verified, prior to baseline, can help to control this cost.

Accountability. The most significant step that needs to be taken in improving the requirement process is that of accountability. Accountability is important for each individual requirement. You need to assign ownership as requirements are written. The owner should be a person with a stake in the requirement and who is knowledgeable about the need for the requirement. The owner should be willing and able to defend the need for the requirement prior to baseline. The owner should be available to assess change impact against the requirement should a change be proposed.

Accountability is even more important at the management level. There has been a trend for large numbers of people to sign a

specification. I have seen instances where a division chief, an associate director and the director signed the specification, but not the program/project manager. These signers had not read the document. The program manager should sign and be held accountable. Higher managers can sign if they wish, but if they sign they should be held accountable.

The quality of the requirements should be part of each program manager's evaluation criteria. The quality and stability of the requirements that they manage are essential to program success and should be a measure of their own success.

Anyone offered a program manager's job should look carefully at the condition of the requirements left by the predecessor. If the requirements are out of control, no other control, short of cleaning up the requirements, will enable the program to be successful.

What all program managers should recognize is that the investment to obtain good requirements is minor compared to the effect on program cost and schedule, and possibly, the manager's career.

Program Control on the Tropical Rainfall Measuring Mission

by Dorothy J. Pennington and Walter Majerowicz

The Tropical Rainfall Measuring Mission (TRMM), an integral part of NASA's Mission to Planet Earth, is the first satellite dedicated to measuring tropical rainfall. TRMM will contribute to an understanding of the mechanisms through which tropical rainfall influences global circulation and climate. Goddard Space Flight Center's (GSFC) Flight Projects Directorate is responsible for establishing a Project Office for the TRMM to manage, coordinate and integrate the various organizations involved in the development and operation of this complex satellite.

The TRMM observatory, the largest ever developed and built inhouse at GSFC, includes state-of-the-art hardware. It will carry five scientific instruments designed to determine the rate of rainfall and the to-

tal rainfall occurring between the north and south latitudes of 35 degrees. As a secondary science objective, TRMM will also measure the Earth's radiant energy budget and lightning.

The complexities of managing an inhouse project are magnified by many non-GSFC interfaces, as shown in Table 1. The TRMM Project Office is responsible for managing the integration of all segments of this complex activity and providing a cohesive team that will deliver a fully functioning observatory within budget and schedule constraints. These interfaces require careful management and coordination of technical, schedule and budget elements. While the project office provides overall program planning, direction and control, the subsystem managers and instrument suppliers

Table 1. TRMM Organization Responsibilities

<i>Component</i>	<i>Responsible Organization</i>
Project Management	TRMM Project
Observatory Subsystems	Engineering Directorate/numerous aerospace companies
Precipitation Radar (PR)	Japan/ NASDA/Toshiba
TRMM Microwave Imager (TMI)	TRMM Project/Hughes
Visible Infrared Scanner (VIRS)	TRMM Project/Santa Barbara Research Center
Clouds and Earth's Radiant Energy System (CERES)	EOS/Langley Research Center/TRW
Lightning Imaging Sensor (LIS)	TRMM Project/Marshall Space Flight Center
TRMM Science Data and Information System (TSDIS)	Earth Sciences Directorate/General Sciences Corporation
Mission Operations	Mission Operations and Data System Directorate
H-II Launch Vehicle and Launch Services	Japan/NASDA
Science Team	Earth Science Directorate, U.S. Universities, JPL, NOAA, Japan, Australia, Israel, France, Taiwan, Great Britain

implement project requirements at a detailed level. One immediate challenge to securing a successful TRMM mission is implementing program control systems that will ensure an August 1997 launch from Tanegashima Space Center, Japan. The August 1997 launch is critical; if TRMM is not launched on time, high levels of solar activity forecast for the late 1990s would result in a reduced mission life. This constraint, along with the limitation of biannual launch windows at the Tanegashima Space Center, places top priority on schedule performance, but not at the expense of technical excellence, safety or cost.

Program Control Overview

The TRMM Program Control staff has established a comprehensive Program Control System that includes schedule management, financial management, configuration management and risk management. The Program Control System is not simply a computer program. Rather, it consists of a series of checks and balances in each of these areas that are designed to keep the entire management system integrated, as

shown in Figure 1. Four monthly reports reflecting analyses in the areas of schedule, finance, general business and risk management are generated by the TRMM program control staff. These reports, called the Program Control Monthly Status Reports (PCMSR), are distributed to TRMM technical and resources management and provide a current, complete analysis of all business issues and concerns. TRMM also conducts monthly status reviews with each of the subsystem, instrument and element managers. During these reviews, each manager is allocated approximately 30 minutes to present technical, cost, schedule and manpower issues and concerns to the TRMM Project Manager. The importance placed on communication, whether through these reviews or in the PCMSR, is one of the key reasons behind the success of the Program Control System.

A major element of the Program Control System is the logic network. Using the project work breakdown structure, the project planners developed an end-to-end network that was baselined shortly after the TRMM System Concept Review.

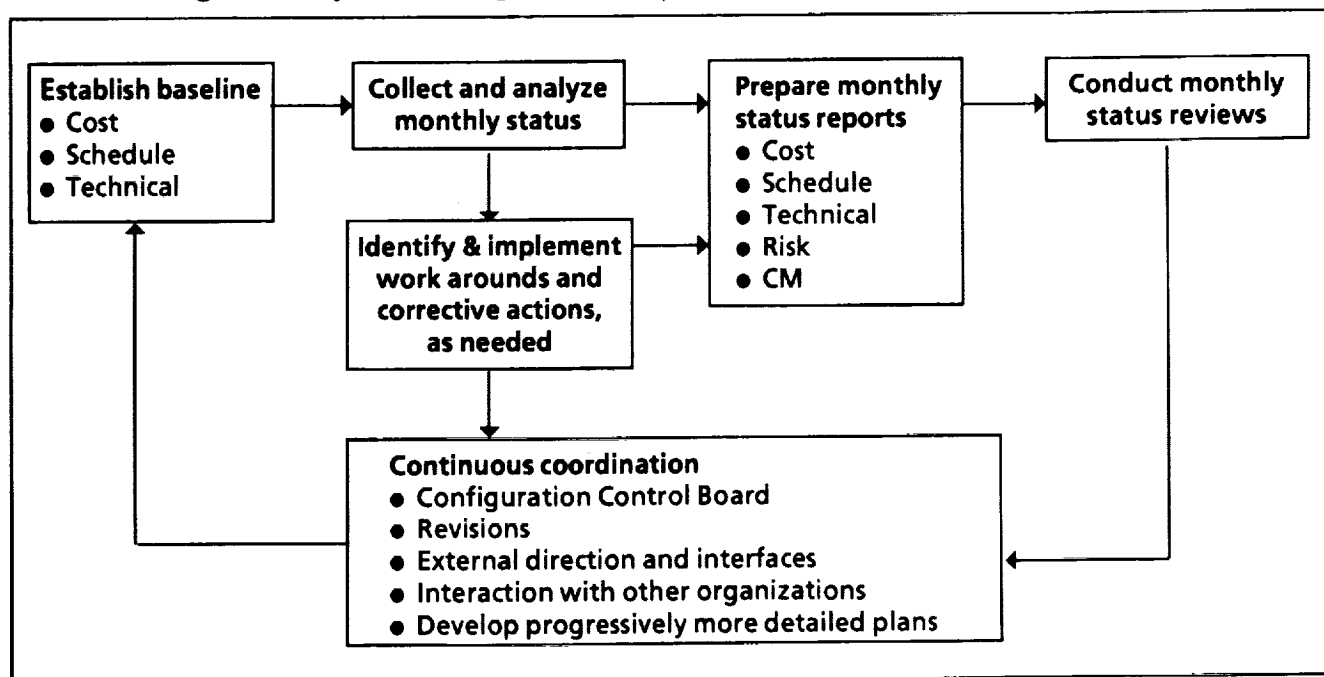

Figure 1. Program Control Process

This network, in conjunction with the mission specifications and agreements, provided the foundation for project management to focus on the preparation of the budget estimates. Careful consideration was given to technical and schedule risks and tradeoffs while attempting to determine annual funding requirements. After the technical, schedule and cost baselines were established, the TRMM Configuration Control Board (CCB) was set up to systematically consider all changes to the baselines. Finally, the risk management report was initiated by the Program Control staff to provide project management with an ongoing early warning system. Using this mechanism, actions to resolve cost, manpower, schedule and technical problems can be quickly identified and implemented. Frequent communication between project managers, subsystem managers, instrument suppliers and the program control staff is the key to maintaining these effective management systems.

■ Schedule Management

The scheduling function is centralized at the project level. The scheduling staff is assigned to the project office and coordinates with both GSFC and outside organizations responsible for the development of the TRMM spacecraft, instrument, and ground segments as well as overall system integration and test (I&T).

The TRMM Program Control staff has developed a comprehensive logic network for TRMM that integrates key work tasks and milestones from all elements within the TRMM system. For work being performed at GSFC, the schedulers prepare the sub-networks in coordination with the responsible subsystem and element technical managers. For work being performed outside of GSFC, schedule data is received

from the contractors' scheduling systems and incorporated into the TRMM schedule database.

A sample portion of the logic network is contained in Figure 2. The information contained in the activity boxes or "nodes" identifies the task description, activity duration in work days, and total slack (the amount of time an activity or event can be delayed before it impacts launch readiness). With the use of TRMM's automated scheduling system for developing and maintaining the logic network, bar charts are easily generated. The bar chart corresponding to the logic network sample presented in Figure 2 is shown in Figure 3. These detailed schedules are "rolled up" to an intermediate level in order to summarize the schedule information for management. Figure 4 depicts how the Thruster detailed schedule is summarized within the Reaction Control Subsystem (RCS) Intermediate Schedule. This "roll-up" or schedule summarization capability, combined with the precedence relationships among the activities in the logic network, provide the framework to properly manage the vertical and horizontal schedule integration and traceability on TRMM.

For effective Program Control of TRMM, maintaining a schedule baseline is as important as maintaining a technical and cost baseline. Moreover, proper configuration management of the TRMM schedule is vital in order to accurately assess the impact of changes. TRMM's formal schedule baseline is identified in the TRMM Project Schedule Baseline Document (PSBD). The PSBD consists of three parts: major project milestones, project control milestones and the Observatory integration and test schedule. The schedule for these milestones can only be changed with the approval of the TRMM Configuration Control Board.

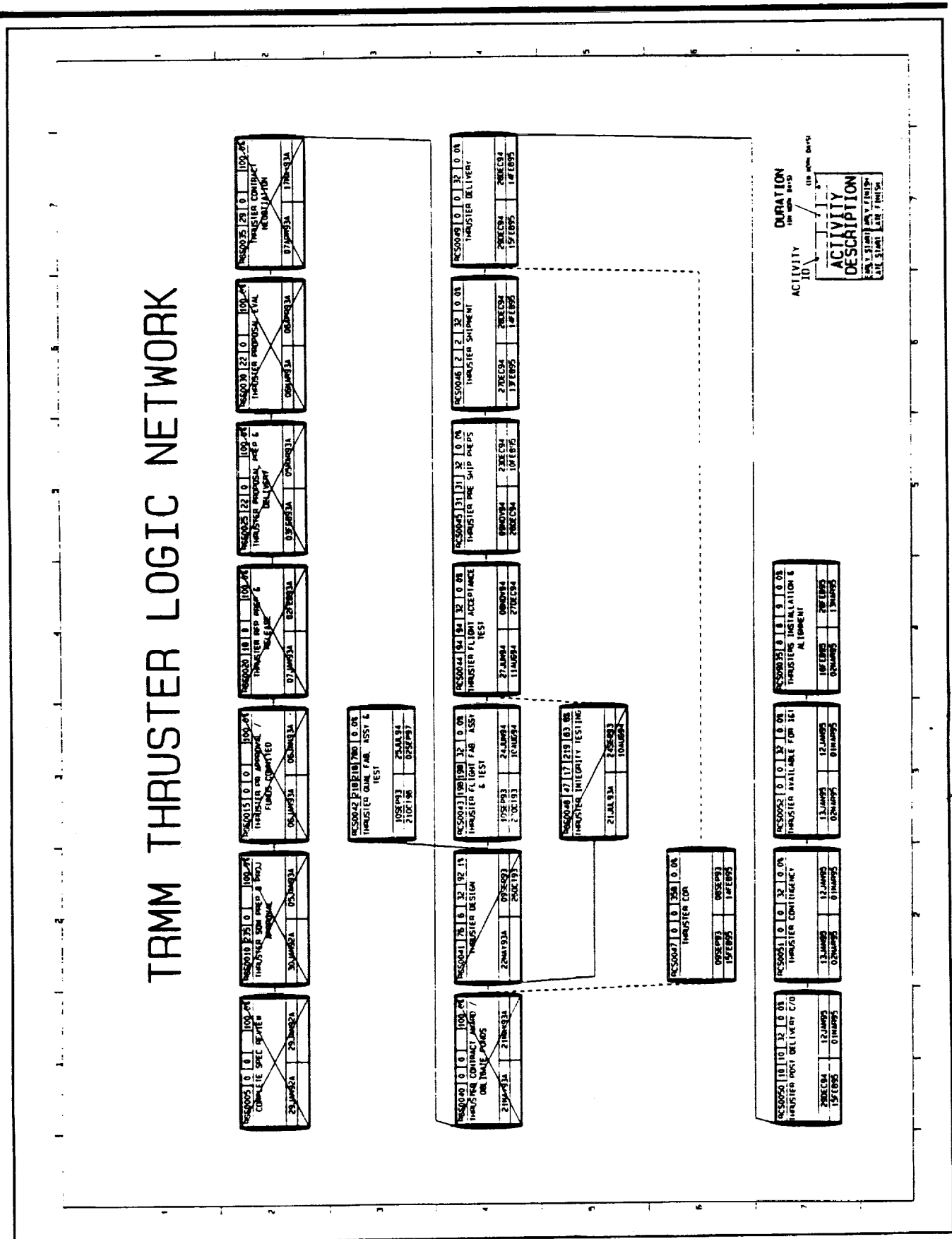

Figure 2. RCS Thruster Logic Network Diagram

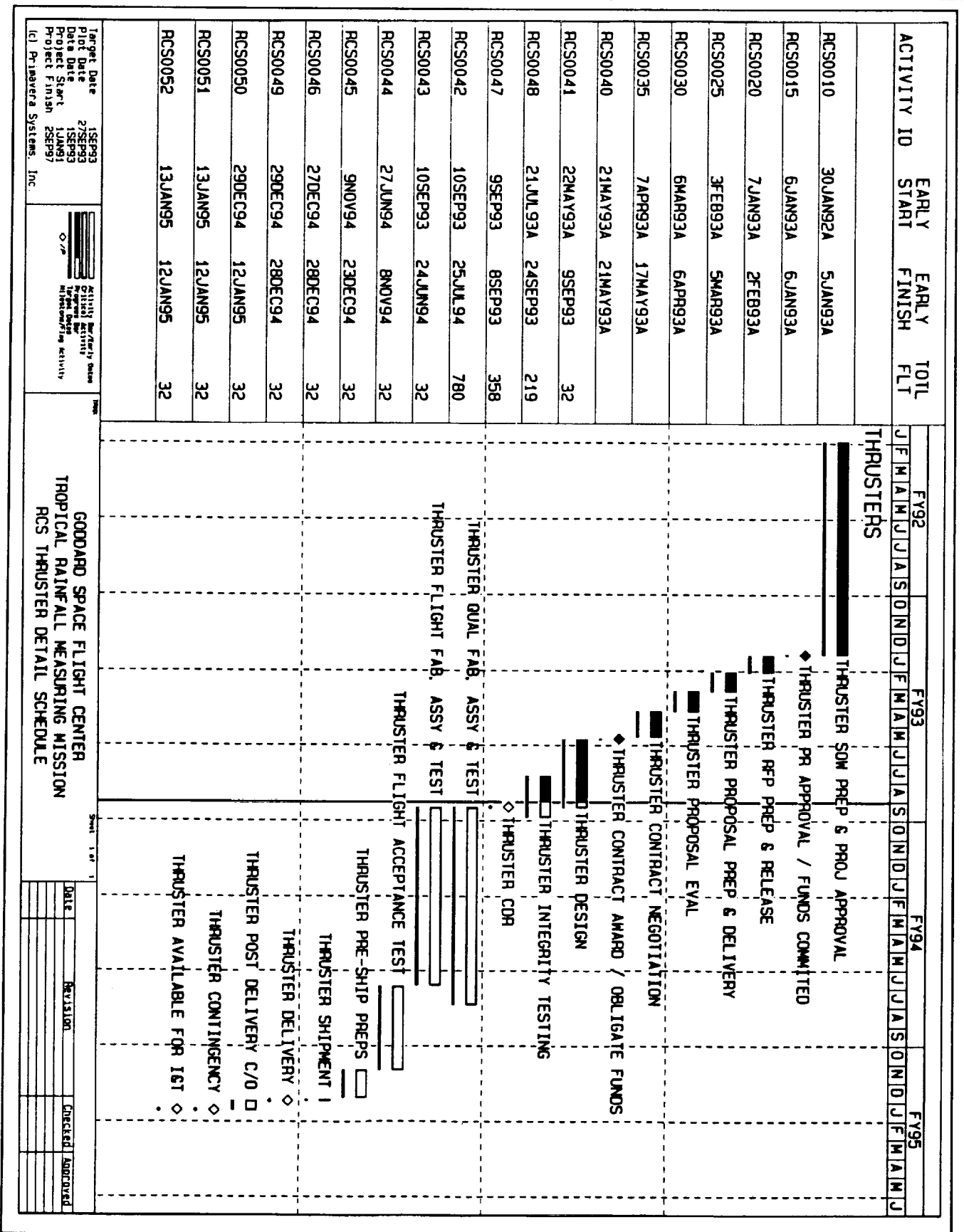

Figure 3. RCS Thruster Detailed Schedule Bar Chart

Program Control on the Tropical Rainfall Measuring Mission

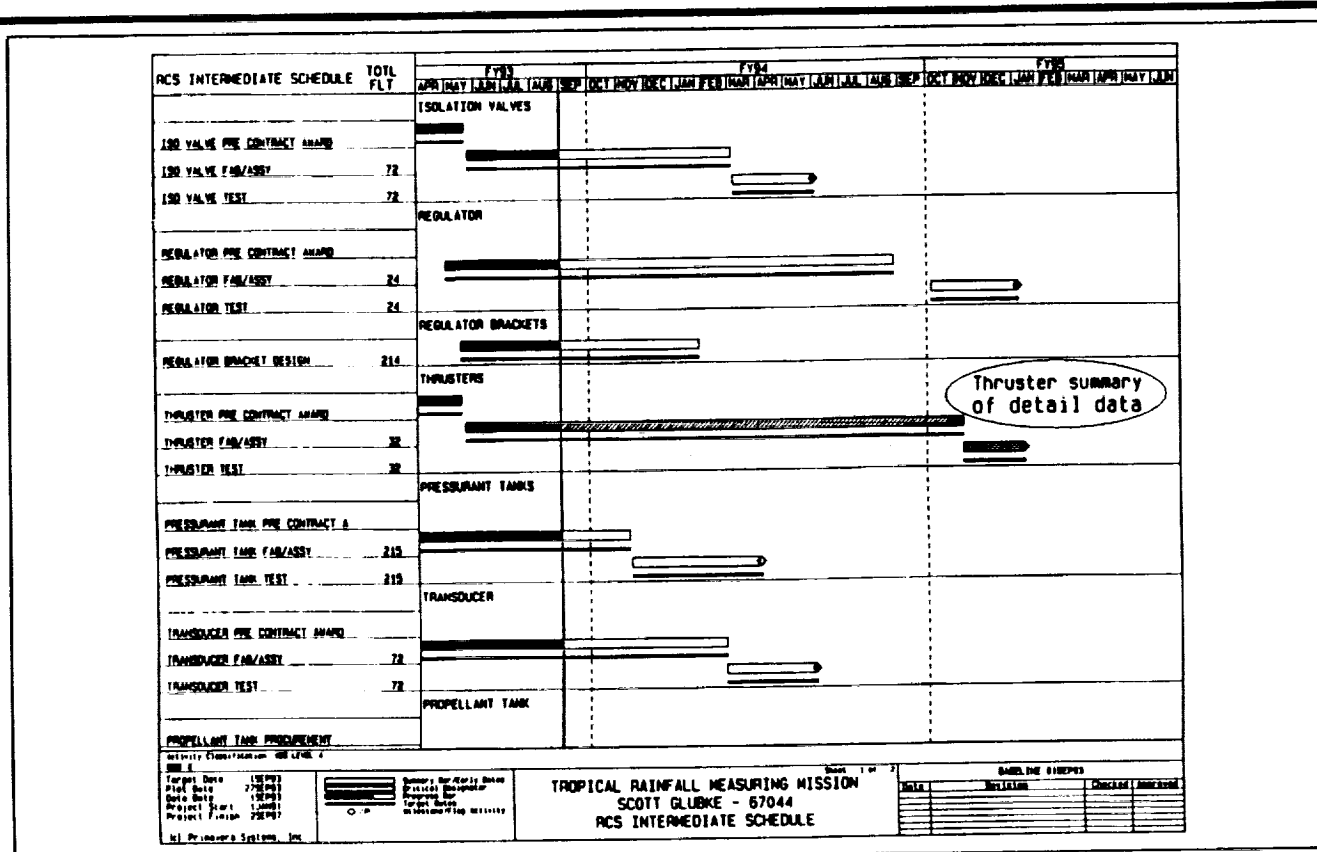

Figure 4. RCS Intermediate Schedule (1 of 2)

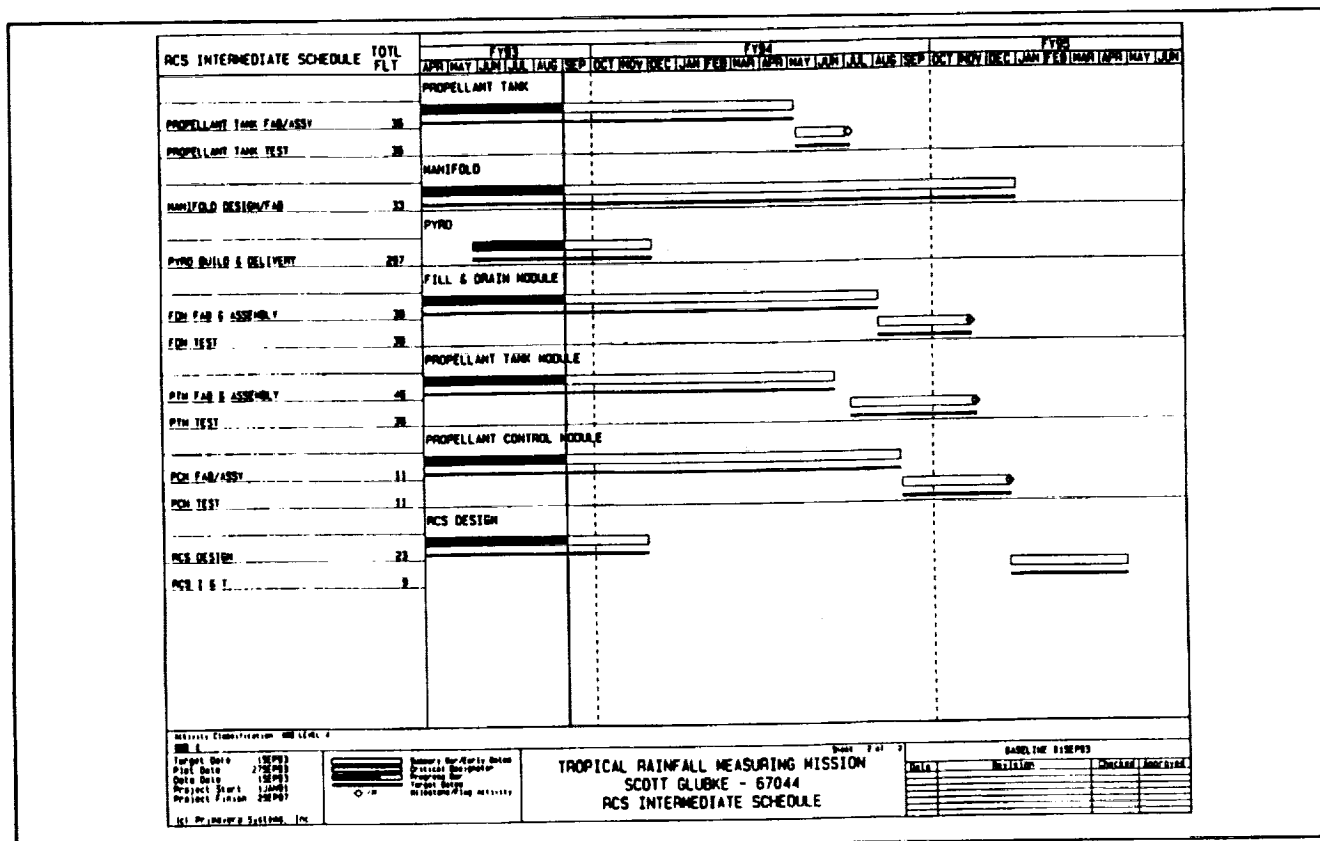

Figure 4. RCS Intermediate Schedule (2 of 2)

The major project milestones provide the framework for overall planning and scheduling for the TRMM spacecraft segment, instrument segment, and ground segment developments, system integration and test, shipping and delivery, and launch site preparations. These milestones, depicted

at the top of the Master Schedule (see Figure 5) consist of the System Concept Review (SCR), Preliminary Design Review (PDR), Critical Design Review (CDR), Pre-Environmental Test Review (PER), Pre-Shipment Review (PSR), and the Launch Readiness Review.

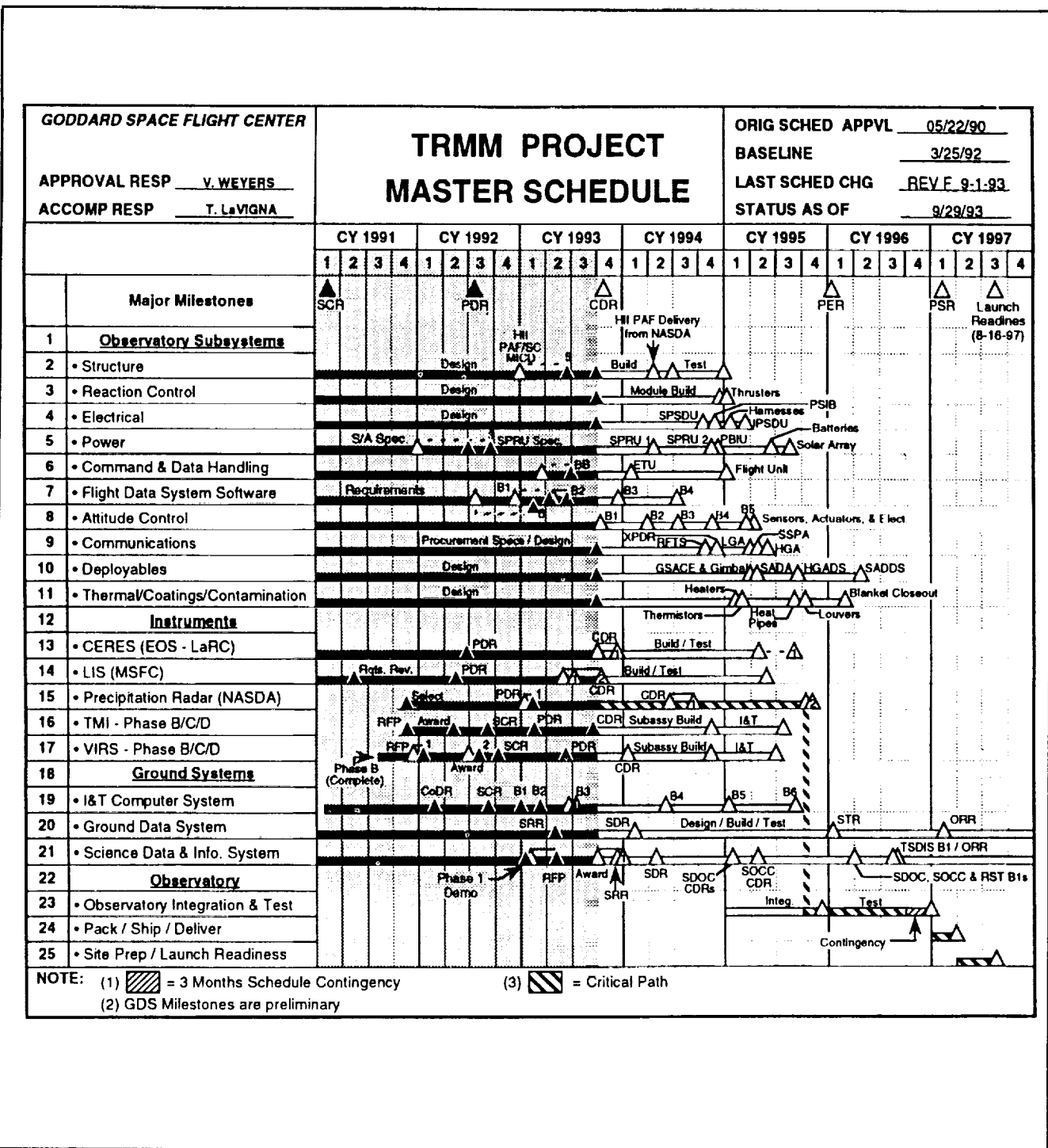

Figure 5. TRMM Project Master Schedule

The project control milestones are events which the TRMM Project Office considers critical. These include, but are not limited to, interface milestones such as the delivery of hardware or software between TRMM organizational elements. Control milestones can also represent the completion of major stages of work within a given subsystem or element. More importantly, they are commitments by the responsible organizations to the TRMM Project Office to accomplish these events as planned.

Next, the TRMM I&T schedule is included in the PSBD because it establishes the need dates for flight hardware and software. Considerable emphasis was placed on establishing the I&T schedule soon after the SCR in February 1991. Moreover, because all of the TRMM elements ultimately come together during integration and test, the I&T schedule has become the "hub" of the overall scheduling process. It is a key planning tool for all of the elements of the spacecraft, instrument and ground segments.

Since the logic network is a continuously evolving tool, it is not directly contained in the PSBD—only the project control milestones are. However, the logic network supports the schedule baseline in that a target version of the network is maintained against which the current status is compared. This concept is illustrated in the sample bar chart presented earlier (see Figure 4). The compressed black line below each activity bar or milestone represents the schedule baseline at the detailed work task level. This provides a correlation between the current schedule and the baseline. Unilateral changes to the logic network by the responsible subsystem or technical managers are permitted, provided they do not impact the project control milestones or necessitate rephasing of the budget.

Schedule status accounting on the TRMM Project occurs formally each month. Work already underway or activities that should have started or been completed since the last accounting period are statused by determining the percentage of work accomplished, the amount of time remaining to complete a task, or the new expected finish date of a task. For the work being performed at GSFC, the responsible subsystem technical managers are interviewed by the schedulers in order to obtain schedule status. In this way, the schedulers receive not only the status, but also the rationale and issues affecting the status. Once the raw status is input into the logic network data base, it is processed, analyzed and verified. This allows schedule issues to be identified, resolved or addressed before status is formally reported in the TRMM Monthly Project Review. For TRMM's scientific instruments, schedule status is received from the instrumentors each month and analyzed prior to incorporation into the logic network.

The key driver in the TRMM schedule is the August 16, 1997 launch readiness date. In addition to monitoring the actual progress of work toward launch readiness, the TRMM schedulers carefully analyze schedule slack. Total slack is a specific, quantitative and easily understood measure of schedule health. Figure 6 depicts the TRMM Total Slack Summary, which presents an overview of progress for a given month. The chart highlights the key elements for the spacecraft, instrument and ground segments. Each month the total slack for the worst case item within each element is elevated to the total slack chart. It is compared to total slack from the previous month, as well as the total slack for that item in the schedule baseline. The benefit of this chart is that TRMM project managers can see the overall health of the TRMM project schedule at a glance.

Element	Baseline		Aug 1993 Total Slack	Sep 1993 Total Slack	Driver
	Master Schedule - Delivery	REV F ³ Total Slack			
Spacecraft Structure	12-30-94	+12 Days	+12 Days	+12 Days	Aft Skirt/Central Cylinder
Reaction Control	12-21-94	+14 Days	+14 Days	+14 Days	Propellant Control Module
Electrical	11-30-94	+53 Days	+53 Days	+53 Days	PSIB
Power	8-18-95	+30 Days	+30 Days	+30 Days	Solar Array Panels
C & DH	1-6-95	+83 Days	+83 Days	+83 Days	C&DH Flight Unit
FDS Software	12-15-93	+83 Days	+83 Days	+83 Days	FDS Build #3
Attitude Control	10-6-93	+32 Days	+32 Days	+32 Days	ACS S/W Build 1
Communications	5-26-95	+46 Days	+46 Days	+46 Days	High Gain Antenna
Deployables	4-24-96	+30 Days	+30 Days	+30 Days	SADDS (Flight Wings)
Thermal	2-26-95	+33 Days	N/A	+33 Days	Thermistors
LIS	6-1-95	+53 Days	+53 Days	+53 Days	Electronics Assembly
CERES	9-1-95	+29 Days	+29 Days	+29 Days	Biaxial Scan Assembly
Precipitation Radar ⁴	10-25-96	+12 Days	+4 Days	+4 Days	Transmitter / Receiver
TMI	8-1-95	+32 Days	+32 Days	+32 Days	Receivers
VIRS	7-1-95	+42 Days	+42 Days	+42 Days	Electronics Module
TSDIS	8-14-96	+35 Days	+35 Days	+35 Days	Contract Award
I&T Computer Systems	6-9-94	+41 Days	+89 Days	+41 Days	I&TCS Build #4
Observatory I&T	10-9-96	+12 Days	+4 Days	+4 Days	Precipitation Radar

NOTE:
 1) 3 month schedule contingency not counted in slack
 2) Total slack calculated in working days
 3) REV F = CDR baseline revision
 4) Baseline PR delivery is need date for observatory I&T



 - Loss in slack from last month 10 days or greater
 - Growth in slack from last month 10 days or greater

Figure 6. TRMM Total Slack Summary

The schedule products such as bar charts and network diagrams are important Program Control tools for TRMM. When combined with a formal status process, they enable the TRMM Project Office to assess the progress of the TRMM schedule. As an early warning mechanism, the scheduling system provides a means to detect potential schedule problems, implement work-around plans, or take corrective action in order to mitigate problems. Scheduling products are tailored to various members of the TRMM team. Tools such as the Total Slack Chart and the Intermediate Schedules provide a way to summarize a tremendous amount of detailed schedule data for TRMM project management. With this information, management can identify key issues, critical paths and potential work-arounds. At the working level, detailed schedule bar charts and logic network diagrams are excellent planning tools.

In summary, the TRMM scheduling system provides reliable information to all levels of users.

Financial Management

A key feature of the Program Control System is cost and schedule integration. As with the scheduling staff, the financial staff is centralized at the project level—although other GSFC organizations also provide financial support for TRMM subsystem managers. The main duty of the financial staff is budget formulation and execution. The logic network schedule serves as a basis for TRMM budget planning. Based on a detailed integration and test sequence, need dates for flight hardware and software have been precisely identified. Budgets were formulated against the time-frame reflected in the schedules, as illustrated in Figure 7.

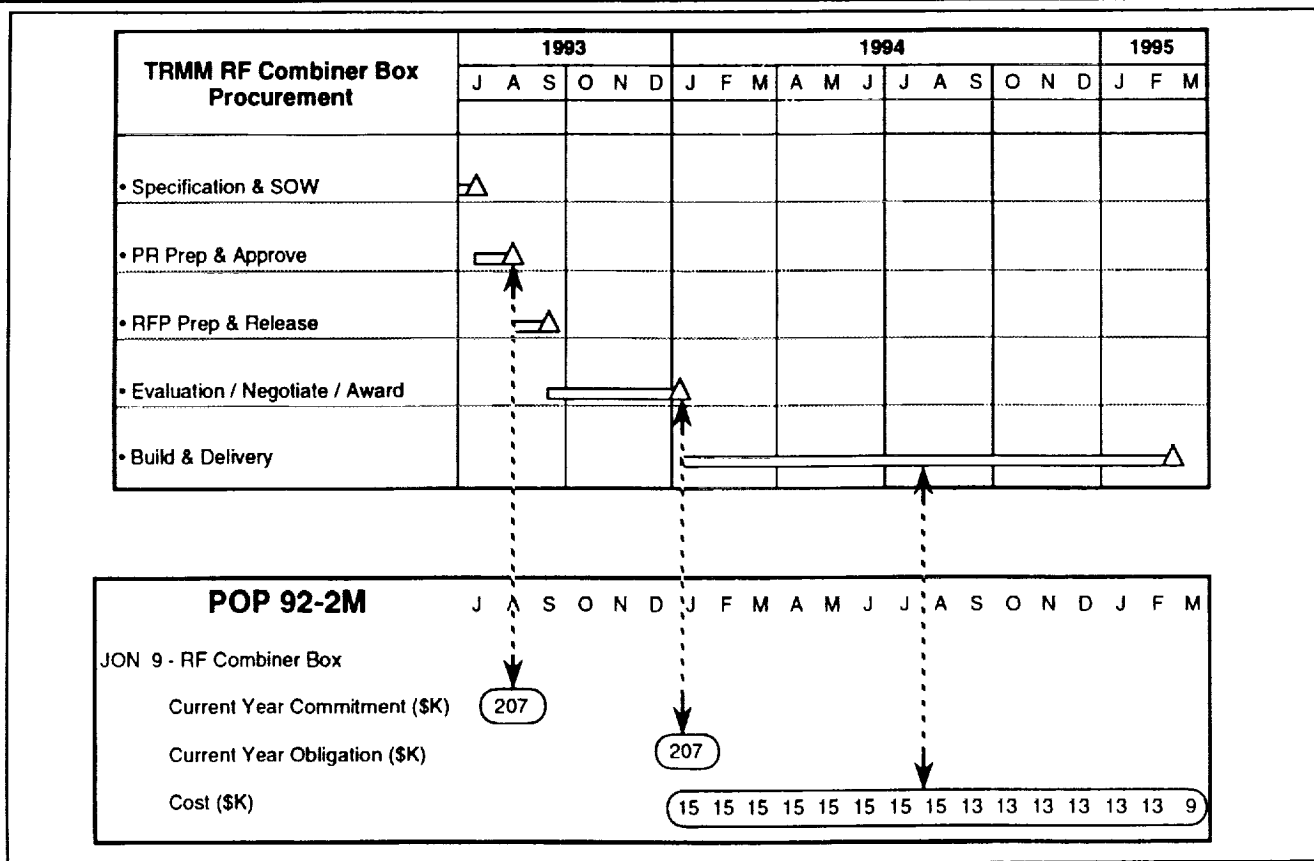

Figure 7. TRMM Cost/Schedule Integration

By integrating cost and schedule planning, the project office can perform what-if budget and schedule simulations. Civil servant manpower and travel budgets were also developed using the schedule to determine the correct phasing of requirements. In a dynamic budget environment, the TRMM Project is quickly able to isolate the impact of schedule delays, personnel shortages and travel cuts on the budget requirements. Similarly, when budgets are reduced, the integrated cost and schedule information provides a framework to quickly determine the scope of work that can be reprogrammed without having undesirable effects on launch readiness.

The TRMM Project has already used this system to identify numerous planned early year, high-cost component purchases that could be deferred to later years, thereby alleviating funding problems without risking the integration and test schedule.

Close coordination between the subsystem and element managers and the TRMM financial staff ensures timely and accurate preparation of budget estimates and procurement requests. Since TRMM is an in-house project, the procurement activities are not focused on several large prime contracts, as typically found in other GSFC projects. Instead, the financial and procurement staffs are responsible for purchasing the components, parts and instruments that will come together as a complete observatory. These extensive procurement activities require detailed planning and coordination to remain on schedule.

The budget was developed for these procurements and supporting effort as discrete items at the Job Order Number (or work package) level. The budget requirements were then "rolled-up" through the project work breakdown structure by month and fiscal year, which ensures that budget data

submitted to NASA Headquarters is based on the detailed estimates for the entire project. As part of the financial system, the TRMM financial staff has developed an extensive contingency tracking system. Details of all changes in the budget baseline are maintained in the contingency (management reserve) tracking system as shown in the summary portion of Table 2. This provides a complete audit trail of all items funded from the contingency line item.

In addition to budgeting and procurement responsibilities, the financial staff analyzes contractor financial performance and ensures that other members of the TRMM project team are kept abreast of financial issues and concerns. The TRMM Microwave Imager contract has requirements for modified Performance Measurement System (PMS) reporting. On a monthly basis, the financial staff prepares a quick-look analysis of the PMS data in the TRMM Program Control Monthly Status Report. Analyses are also prepared for other contracts and for fiscal activity.

■ Configuration Management

TRMM's integrated program control approach also closely aligns cost and schedule management with configuration management (CM) activities. TRMM's configuration management system provides a disciplined approach for controlling the changes to the requirements in hardware, software, performance, schedule and cost. Budget, schedule and technical requirements were established as integrated baselines early in the project's life. As changes to the established baselines occur, they are formally presented to the TRMM CCB.

The CCB, composed of technical and administrative representatives from each project discipline, evaluates the positive or

negative impact of each change on the budget, schedule, and technical baselines. With this integrated, accurate approach to cost and schedule assessment, the impact of engineering changes can be quickly and thoroughly evaluated across the project. The TRMM Project Office has a goal to evaluate all changes within 45 days of the initial change request. A work progress indicator for the CM process has been incorporated into the Risk Management System.

■ Risk Management

Risk management is another key element of TRMM's integrated program control process. The Risk Management System emphasizes detection and resolution of problems in areas identified as having risk potential. The system allows managers to identify program risks and to implement alternate plans to mitigate the impact of unresolved problems, as shown in Figure 8. Cost, schedule and technical risk parameters have been identified for TRMM to quantitatively measure program health and ultimately program risk.

Figure 9 shows the elements of the project that are tracked in the monthly Risk Assessment Report. Technical indicators include power, mass, data rate and mission life. Management indicators include finance, schedule, configuration management, manpower and procurement. These risk indicators have been identified to provide a quantifiable goal against which progress is measured. Each indicator has three tolerance levels or alert zones used to indicate the level of risk.

First, risk is classified as a major impact if the indicator's performance reflects the existence or imminent threat of major problems, concerns or similar severe impacts upon accomplishment of project requirements.

Table 2. Contingency Tracking System

28-Sep-93

TRMM PROJECT -- CONTINGENCY TRACKING SYSTEM

ENCUMBRANCE SUMMARY:

CAT	DESCRIPTION	POP	FY 91	FY 92	FY 93	FY 94	FY 95	FY 96	FY 97	TOTAL
1	REPHASE/RELOCATE	ALL	0	455	387	1559	-3936	-193	1728	0
2	ADJ TO PROPOSAL/NEGOTIATED/LATEST ESTIMATE	ALL	60	1546	-2543	2913	-945	-1719	-562	-1250
3	MINOR/MISC (EACH ACTION < \$100K)	ALL	201	-180	1129	-109	326	-47	149	1469
4	ITEMIZED									
4 POP	05/28/93 MSSN OPS	93-1					103	162	210	475
4 POP	05/28/93 S/W MGMT	93-1				1050	375	250	125	1800
4 POP	05/28/93 TEST	93-1			-6	-734	-207	48	-247	-1146
4 POP	05/28/93 PROD ASSUR	93-1			137	229	166			532
4 OB-0035	06/30/92 POWER	92-2M			-100	75	-650			-675
4 MEMO	01/14/93 POWER	93-1			576	-2635	-1444	-44	-47	-3594
4 OB-0001	06/13/91 POWER	92-1			100	967	966	866		2899
4 POP	10/28/92 POWER	92-2M			-100	-95				-195
4 OB-0066	12/18/92 RCS	93-1			230					230
4 POP	05/28/93 ELEC	93-1		195	346	-115	-24			207
4 OB-0035	06/30/92 ELEC	92-2M			462	638	68			1363
4 POP	10/28/92 ELEC	92-2M			66	75	105	137	80	463
4 OB-0035	06/30/92 C&DH	92-2M			-489	-200				-689
4 OB-0013	04/28/92 C&DH	92-2			-583	-623				-1206
4 POP	05/28/93 FLIGHT S/W	93-1			10	140	143	215	118	626
4 MEMO	03/01/93 GRND SYS	93-1			354					354
4 MEMO	01/22/93 GRND SYS	93-1			285					285
4 GN-0030	06/09/92 SPT GRND	92-2M		160	25	36	48	60	73	160
4 POP	05/28/93 GRND SYS	93-1			-120	-160	-120			-400
4 IN-0106	03/22/93 TMI	93-1			418					418
4 POP	05/28/93 VIIRS	93-1				1670	510	132	374	506
4 POP	05/28/93 MPS	93-1						1220	-62	3338
4 POP	05/28/93 MPS	93-1								
SUBT 4			0	355	1193	736	39	3046	624	5993
TOTAL			261	2176	167	5098	-4516	1087	1939	6212

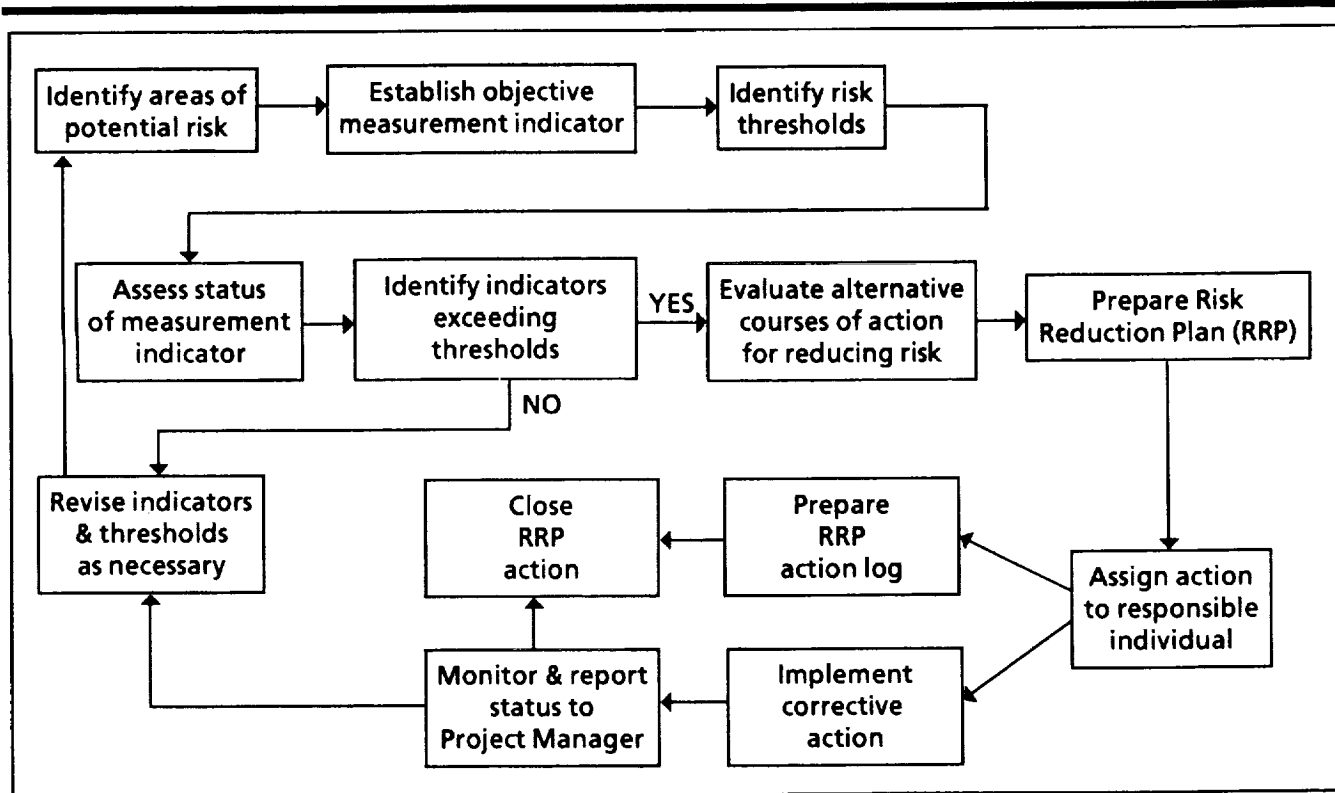

Figure 8. TRMM Risk Management Process

For Month Ending

Critical Design Parameters		Project Management	
<input type="checkbox"/> Data Storage - Memory Usage	<input type="checkbox"/> Weight Margin	<input type="checkbox"/> Civil Service Workforce	<input type="checkbox"/> Configuration Changes
<input type="checkbox"/> OBC - EEPROM Memory Usage	<input type="checkbox"/> Mission Life	<input type="checkbox"/> Schedule Contingency	<input type="checkbox"/> Logistics / Operations
<input type="checkbox"/> OBC - ACS EEPROM Memory Usage	<input type="checkbox"/> Reliability	<input type="checkbox"/> Financial Contingency	<input type="checkbox"/> Facilities & Test Equipment
<input type="checkbox"/> Power Margin	<input type="checkbox"/> Drawing Release	<input type="checkbox"/> Procurement	

Observatory Subsystems	Instruments	Ground System																																																																																																	
<table border="0"> <tr><td><input type="checkbox"/></td><td><input type="checkbox"/></td><td><input type="checkbox"/></td><td><input type="checkbox"/></td><td>Structure</td></tr> <tr><td><input type="checkbox"/></td><td><input type="checkbox"/></td><td><input type="checkbox"/></td><td><input type="checkbox"/></td><td>RCS</td></tr> <tr><td><input type="checkbox"/></td><td><input type="checkbox"/></td><td><input type="checkbox"/></td><td><input type="checkbox"/></td><td>Electrical</td></tr> <tr><td><input type="checkbox"/></td><td><input type="checkbox"/></td><td><input type="checkbox"/></td><td><input type="checkbox"/></td><td>Power</td></tr> <tr><td><input type="checkbox"/></td><td><input type="checkbox"/></td><td><input type="checkbox"/></td><td><input type="checkbox"/></td><td>C&DH</td></tr> <tr><td></td><td></td><td><input type="checkbox"/></td><td><input type="checkbox"/></td><td>Flight Software</td></tr> <tr><td><input type="checkbox"/></td><td><input type="checkbox"/></td><td><input type="checkbox"/></td><td><input type="checkbox"/></td><td>ACS</td></tr> </table>	<input type="checkbox"/>	<input type="checkbox"/>	<input type="checkbox"/>	<input type="checkbox"/>	Structure	<input type="checkbox"/>	<input type="checkbox"/>	<input type="checkbox"/>	<input type="checkbox"/>	RCS	<input type="checkbox"/>	<input type="checkbox"/>	<input type="checkbox"/>	<input type="checkbox"/>	Electrical	<input type="checkbox"/>	<input type="checkbox"/>	<input type="checkbox"/>	<input type="checkbox"/>	Power	<input type="checkbox"/>	<input type="checkbox"/>	<input type="checkbox"/>	<input type="checkbox"/>	C&DH			<input type="checkbox"/>	<input type="checkbox"/>	Flight Software	<input type="checkbox"/>	<input type="checkbox"/>	<input type="checkbox"/>	<input type="checkbox"/>	ACS	<table border="0"> <tr><td><input type="checkbox"/></td><td><input type="checkbox"/></td><td><input type="checkbox"/></td><td><input type="checkbox"/></td><td>Communications</td></tr> <tr><td><input type="checkbox"/></td><td><input type="checkbox"/></td><td><input type="checkbox"/></td><td><input type="checkbox"/></td><td>Deployables</td></tr> <tr><td><input type="checkbox"/></td><td><input type="checkbox"/></td><td><input type="checkbox"/></td><td></td><td>Thermal</td></tr> <tr><td></td><td></td><td><input type="checkbox"/></td><td></td><td>Thermal Coatings</td></tr> <tr><td></td><td></td><td><input type="checkbox"/></td><td><input type="checkbox"/></td><td>Test & Verification</td></tr> <tr><td></td><td></td><td><input type="checkbox"/></td><td></td><td>Contamination</td></tr> <tr><td><input type="checkbox"/></td><td><input type="checkbox"/></td><td><input type="checkbox"/></td><td><input type="checkbox"/></td><td>Gimbal</td></tr> </table>	<input type="checkbox"/>	<input type="checkbox"/>	<input type="checkbox"/>	<input type="checkbox"/>	Communications	<input type="checkbox"/>	<input type="checkbox"/>	<input type="checkbox"/>	<input type="checkbox"/>	Deployables	<input type="checkbox"/>	<input type="checkbox"/>	<input type="checkbox"/>		Thermal			<input type="checkbox"/>		Thermal Coatings			<input type="checkbox"/>	<input type="checkbox"/>	Test & Verification			<input type="checkbox"/>		Contamination	<input type="checkbox"/>	<input type="checkbox"/>	<input type="checkbox"/>	<input type="checkbox"/>	Gimbal	<table border="0"> <tr><td><input type="checkbox"/></td><td><input type="checkbox"/></td><td>LIS</td></tr> <tr><td><input type="checkbox"/></td><td><input type="checkbox"/></td><td>TMI</td></tr> <tr><td><input type="checkbox"/></td><td><input type="checkbox"/></td><td>VIRS</td></tr> <tr><td><input type="checkbox"/></td><td><input type="checkbox"/></td><td>CERES</td></tr> <tr><td><input type="checkbox"/></td><td><input type="checkbox"/></td><td>PR</td></tr> <tr><td><input type="checkbox"/></td><td><input type="checkbox"/></td><td>TSDIS</td></tr> <tr><td><input type="checkbox"/></td><td><input type="checkbox"/></td><td>POCC</td></tr> <tr><td><input type="checkbox"/></td><td><input type="checkbox"/></td><td>PACOR</td></tr> <tr><td><input type="checkbox"/></td><td><input type="checkbox"/></td><td>FDF</td></tr> </table>	<input type="checkbox"/>	<input type="checkbox"/>	LIS	<input type="checkbox"/>	<input type="checkbox"/>	TMI	<input type="checkbox"/>	<input type="checkbox"/>	VIRS	<input type="checkbox"/>	<input type="checkbox"/>	CERES	<input type="checkbox"/>	<input type="checkbox"/>	PR	<input type="checkbox"/>	<input type="checkbox"/>	TSDIS	<input type="checkbox"/>	<input type="checkbox"/>	POCC	<input type="checkbox"/>	<input type="checkbox"/>	PACOR	<input type="checkbox"/>	<input type="checkbox"/>	FDF
<input type="checkbox"/>	<input type="checkbox"/>	<input type="checkbox"/>	<input type="checkbox"/>	Structure																																																																																															
<input type="checkbox"/>	<input type="checkbox"/>	<input type="checkbox"/>	<input type="checkbox"/>	RCS																																																																																															
<input type="checkbox"/>	<input type="checkbox"/>	<input type="checkbox"/>	<input type="checkbox"/>	Electrical																																																																																															
<input type="checkbox"/>	<input type="checkbox"/>	<input type="checkbox"/>	<input type="checkbox"/>	Power																																																																																															
<input type="checkbox"/>	<input type="checkbox"/>	<input type="checkbox"/>	<input type="checkbox"/>	C&DH																																																																																															
		<input type="checkbox"/>	<input type="checkbox"/>	Flight Software																																																																																															
<input type="checkbox"/>	<input type="checkbox"/>	<input type="checkbox"/>	<input type="checkbox"/>	ACS																																																																																															
<input type="checkbox"/>	<input type="checkbox"/>	<input type="checkbox"/>	<input type="checkbox"/>	Communications																																																																																															
<input type="checkbox"/>	<input type="checkbox"/>	<input type="checkbox"/>	<input type="checkbox"/>	Deployables																																																																																															
<input type="checkbox"/>	<input type="checkbox"/>	<input type="checkbox"/>		Thermal																																																																																															
		<input type="checkbox"/>		Thermal Coatings																																																																																															
		<input type="checkbox"/>	<input type="checkbox"/>	Test & Verification																																																																																															
		<input type="checkbox"/>		Contamination																																																																																															
<input type="checkbox"/>	<input type="checkbox"/>	<input type="checkbox"/>	<input type="checkbox"/>	Gimbal																																																																																															
<input type="checkbox"/>	<input type="checkbox"/>	LIS																																																																																																	
<input type="checkbox"/>	<input type="checkbox"/>	TMI																																																																																																	
<input type="checkbox"/>	<input type="checkbox"/>	VIRS																																																																																																	
<input type="checkbox"/>	<input type="checkbox"/>	CERES																																																																																																	
<input type="checkbox"/>	<input type="checkbox"/>	PR																																																																																																	
<input type="checkbox"/>	<input type="checkbox"/>	TSDIS																																																																																																	
<input type="checkbox"/>	<input type="checkbox"/>	POCC																																																																																																	
<input type="checkbox"/>	<input type="checkbox"/>	PACOR																																																																																																	
<input type="checkbox"/>	<input type="checkbox"/>	FDF																																																																																																	

Legend

<input type="checkbox"/>	No Impact	Category:
<input checked="" type="checkbox"/>	Potential Impact	T = Technical
<input checked="" type="checkbox"/>	Major Impact	M = Mass
		P = Power
		D = Data Rate
		C = Cost
		M/P = Manpower
		S = Schedule

Figure 9. TRMM Risk Assessment Summary

Second, the risk is identified as a potential impact if performance reflects the existence of problems, concerns or potential impacts on the project unless timely and effective action is taken. In the third category, the risk poses no negative impact on meeting TRMM cost, schedule and technical requirements. When an alert zone threshold is passed, an analysis is conducted by the responsible manager to determine the cause of the problem and a corrective action plan is generated to restore the indicator to the desired state. The Risk Reduction Plan documents these products and provides an audit trail for the project to assign, track and close the corrective actions.

Figure 10 illustrates the risk indicator summary for the TRMM Configuration Change Requests. The project recognizes that failure to act upon change requests in a timely manner could affect the project's ability to accomplish cost and schedule goals. The alert zones reflect the project's

Configuration Changes

Purpose: To track the status of engineering changes (Class I) in terms of timely action to avoid schedule and/or cost impact.

Data ground rules:

- Track age of Configuration Change Requests (CCRs)
- Change quantity measured by count of approved change logged into configuration control.

Alert zones:

- No Impact or Age of CCR less than 45 days
- ▨ Potential Impact or Age of CCR between 45 and 60 days
- Major Impact Age of CCR over 60 days

Figure 10. TRMM (CCRs) Indicator Summary

goals for the disposition of all change requests in 45 days. The accompanying status shown in Figure 11 provides a monthly record of TRMM's performance against these pre-established thresholds.

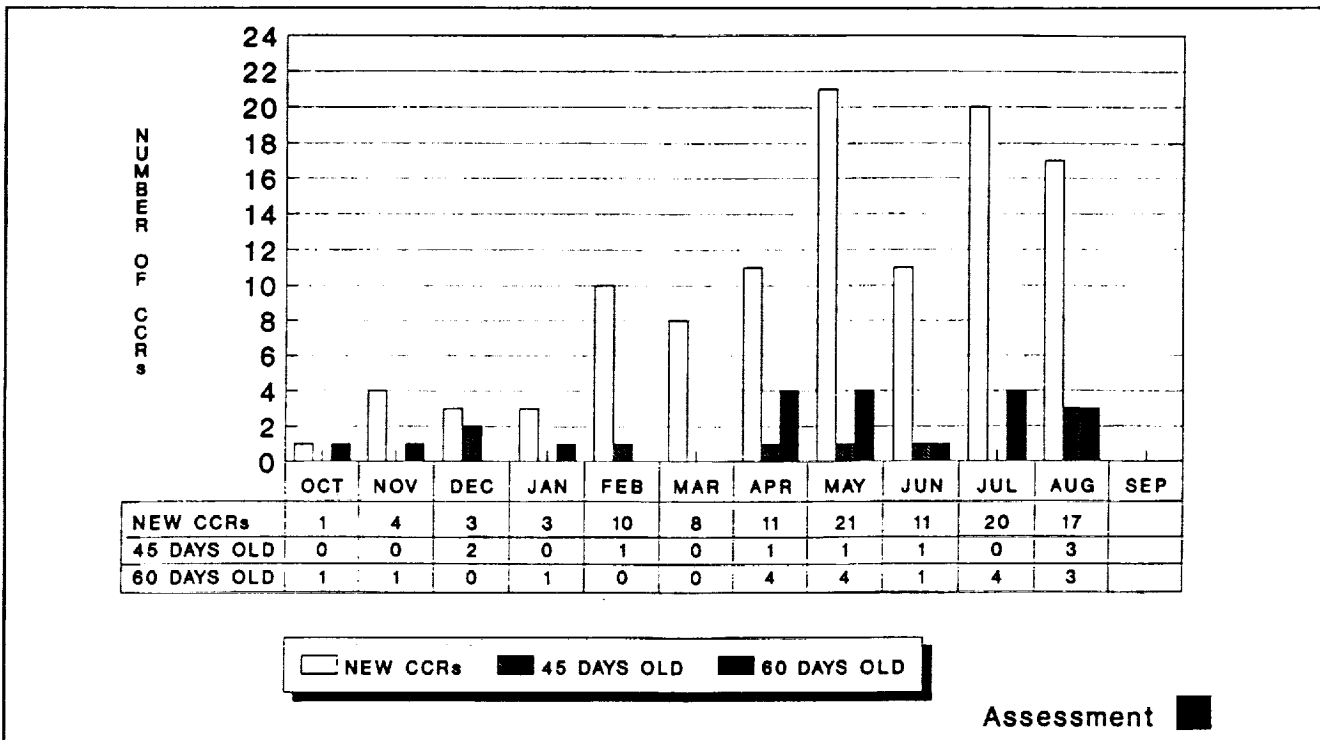

Figure 11. TRMM Project Configuration Change Requests

When the assessment is unfavorable, a Risk Reduction Plan is generated (Figure 12) which analyzes the cause, impact and corrective action. The thresholds for the alert zones were set jointly by the responsible subsystem manager and the project manager, and are intended to represent a reasonable goal for that indicator. These thresholds were sometimes adjusted several times in the preliminary months of the Risk Assessment Report until all parties felt that the appropriate goals were reflected accurately.

Figure 13 shows the risk indicator for the RCS schedule slack. This indicator, used for all subsystems and instruments, tracks slack trend status. Each month, the actual slack is compared to pre-established thresholds and risk reduction plans are generated as needed.

In RCS, the January 1993 slack dropped to 16 days due to a technical change in the thruster configuration. Since the first risk threshold of 32 days was passed, a Risk Reduction Plan was generated (Figure 14). This problem was resolved in May 1993 by negotiating an earlier delivery with the vendor at contract award, with no additional cost. This action increased the thruster slack to 33 days. With the thruster slack no longer in an alert zone, attention was then focused on the element with the least amount of slack, the Propellant Control Module (PCM).

The risk management system has allowed the project staff to effectively use constrained resources to focus on problems which could negatively impact cost, schedule or technical objectives. Although the system requires a great deal of discipline,

Log Number _____

TRMM PROJECT RISK REDUCTION PLAN

Problem Description _____ Name of Indicator _____

Originator _____ Date _____ Phone Number _____

Check the Alert Zone that applies:

Major Impact
 Potential Impact
 No Problem, but has unfavorable trend
 No Problem, but RRP desirable

Potential Impact: Cost Schedule Technical Performance

Describe Problem

1. Summarize problem, identify cause, quantify impact to cost, schedule technical performance.

2. List hardware and/or software configured items affected.

Corrective Action Plan (Be specific, include dates when problem is expected to be resolved, attach separate schedule if necessary.)

Functional Manager Concurrence _____ Project Manager Concurrence _____

Figure 12. TRMM Project Risk Reduction Plan

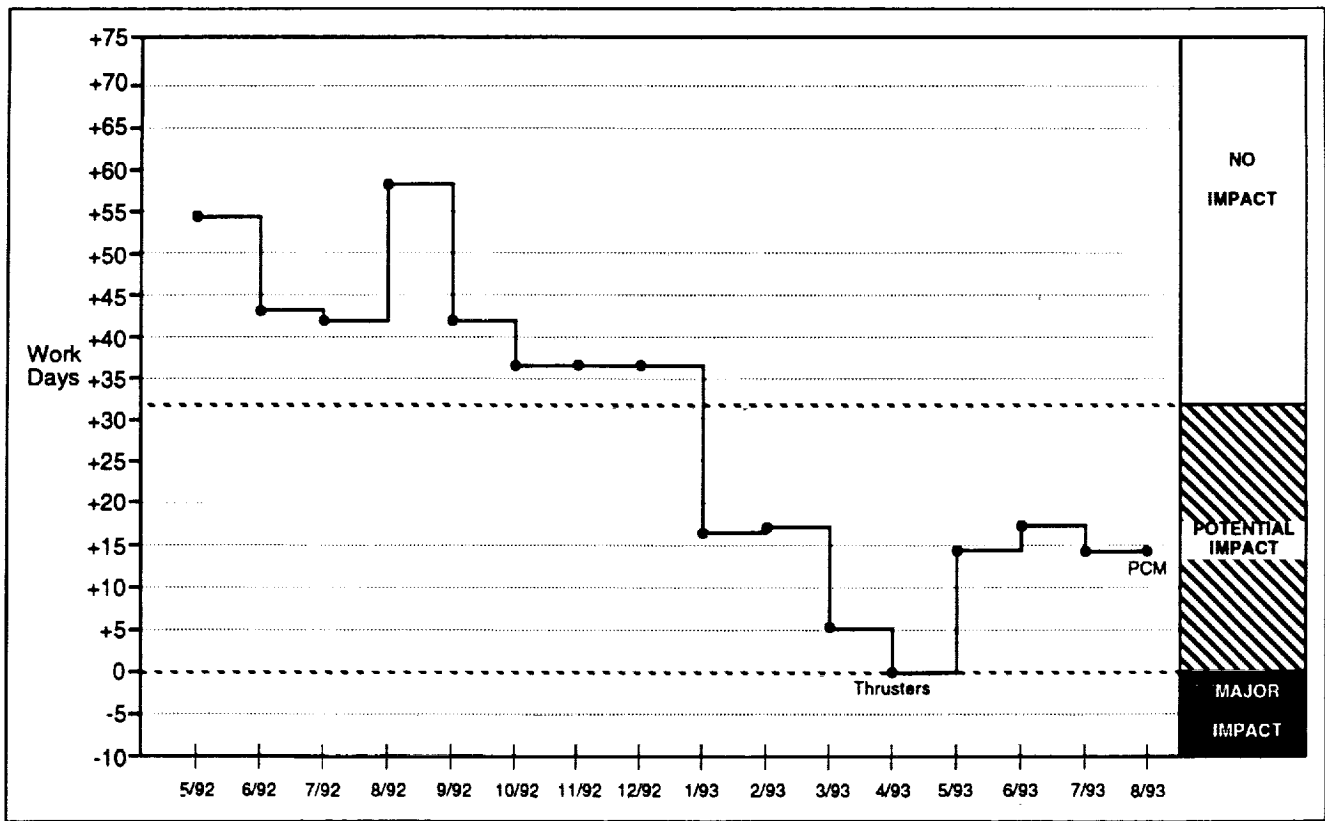

Figure 13. TRMM Reaction Control Subsystem Total Slack

Log Number 16

TRMM PROJECT RISK REDUCTION PLAN

Problem Description RCS - Schedule Name of Indicator Observatory Schedule

Originator Walt Majorowicz Date 1/15/93 Phone Number x 5622

Check the Alert Zone that applies:

Major Impact Potential Impact No Problem, but has unfavorable trend No Problem, but RRP desirable

Potential Impact: Cost Schedule Technical Performance

Describe Problem

- Summarize problem, identify cause, quantify impact to cost, schedule technical performance.
Delivery of thruster delayed due to CCR OB-0066; total slack now +17 which is in excess of Alert Zone 1.
- List hardware and/or software configured items affected.

Corrective Action Plan (Be specific, include dates when problem is expected to be resolved, attach separate schedule if necessary.)

- Release RFP by 4/2/93 need technical and schedule estimates from bidder's in order to determine if 20.5 month lead time is realistic.
- Begin investigating work-around plan for I&T assuming thruster impact.

Functional Manager Concurrence _____ Project Manager Concurrence _____

Figure 14. TRMM Project Risk Reduction Plan

planning and teamwork, the ultimate result focuses the entire project team on the critical problems. To date, the TRMM Project has succeeded in achieving its cost and schedule goals, and the TRMM Project Office can provide GSFC and NASA management with very reliable status and forecast information. The TRMM Project Office's proactive management approach emphasizes prevention rather than correction. The ability to provide early warning and quick-reaction analysis when changes occur allows the team to make informed de-

isions and to optimize positive results. TRMM technical, resource and management personnel clearly understand their role in aggressively managing their responsibilities. TRMM's commitment to excellence, teamwork and communication will ensure the development of a high-quality satellite, delivered on schedule and within the approved budget. This progressive management system is one of the TRMM Project's contributions to improving NASA project management effectiveness and efficiency.

The Project Management Method

by Thomas G. Johns

An unmistakable trend in management views its role as a support system to work that flows horizontally across the organization. The work conducted by people who are chosen from across the company work in joint participation as a team to fulfill the needs of customers. The actions and behaviors of these people, as well as the actions and behaviors of people who support them, constitute a project. The creation and orchestration of these actions and behaviors is project management. The trend is thus toward viewing the company's organization as providing support to these teams who satisfy the needs of customers through the conduct of projects.

Coordination and orchestration of the project team's actions and behaviors are the responsibility of one of the team members, a project manager. The project manager, sometimes likened by Peter Drucker to the conductor of a symphony, in general will not possess all the competencies necessary to fulfill the needs of the customer, but, nonetheless, is empowered by the company to fulfill these needs. This method of management is the project management method. Is it new to NASA? No; in fact, NASA pioneered some of the basic notions of the method. Is it being appropriately implemented? In some places, yes. But frequently people have different views of what project management is, what their role should be, and how to implement it, all of which can result in disharmony.

About five years ago at a PPMI planning session, while discussing management development needs of NASA staff and how these needs were being addressed in one of JSC's project management courses, an in-

vited staffer asked: "Why do we need all that human factors stuff in the course? What does that have to do with project management?"

Before the industrial era, tailors, carpenters, shoemakers, milkmen and blacksmiths all knew their customers by name. As Edwards Deming points out, they knew whether their customers were satisfied and what was required to satisfy them. In the industrial era, one individual could not possess, much less understand, all the competencies necessary to satisfy customers, so companies were formed. These early companies often likened themselves to kingdoms and governments of the 17th or 18th centuries, where people did not own things or feel a sense of participation, but were subservient to the management of the company. Individuals did what they were told to do and had their place.

Such systems of government did not survive when competing with those following the French and American revolutions. These new governments were based on a new order founded by Hobbes, Locke and Rousseau, who asserted that all citizens have the right to own and keep things. Systems designed to incorporate this valued right of individuals would outperform systems that did not incorporate this right.

Companies now tend to have management systems that foster greater participation and ownership by project team members. They are designed to take into account different cultures and values (personal, corporate and societal), different cognitive management styles, the nature of the project and the business situation.

Basic behaviors on which the project management method is built are much the same as those stressed by Drucker and Deming, in versions of TQM, ISO 9000, etc., and they can be easily remembered with the help of an acronym, C.O.S.T. Each letter stands for a concept basic to the method: Customer, Ownership, System and Teamwork.

■ Customer

As the blacksmith was an extension of a farmer's need for iron work, NASA project team members are likewise extensions of needs of their customers, who can be internal or external to the Agency. The first opportunity to create defective work is to misunderstand a customer's needs. Time spent ensuring that the project objectives and requirements are clearly understood, communicated and agreed upon has an immediate impact on improving project quality, reduction of reworks, and reduction in the number of costly changes. The project manager should ask: Who are my customers? Do I talk to them directly? Am I sure that I understand their true needs? Are we communicating with customers clearly?

■ Ownership

Outside of the valued rights of life and liberty first set forth by Hobbes, Locke and Rousseau, a most cherished value is *ownership*. The greater the participation in establishing project and task objectives by the team members who can do the work, the stronger will be their attachment and sense of ownership of that work, and the more likely it will be that the objectives are met.

The project manager should ask: Has the project team developed a breakdown of the work with tasks whose outputs are work products? Is someone responsible for these

work products? Do we have a project organization that has a one-to-one relationship with the work breakdown (one name in each box)? Is the project organization well known, and has it been coordinated with other unit managers?

■ System

The project management system consists of creating *behaviors* in three functional areas: Planning, Leadership and Control.

Planning. Planning is determining *what* needs to be done, by *whom*, *when* and at what expense of resource in order to fulfill the customer's needs. Without planning, a project will be out of control, in free fall, i.e., "It's over when it's over" because there is no basis for control.

Five basic management tools are used to create appropriate planning behaviors. The extent and rigor of their use must be allowed to differ, because projects, people and situations differ. Even for the smallest project, each tool is used.

1. **Project Objectives.** The behavior created by the development of project objectives is *concurrence and agreement* with customers. Costly mistakes are frequently made by having poorly established objectives that contribute to high change traffic, defects in service, poor relationships and mistrust. In effective project management, a lot of time is spent in making sure objectives are clear, measurable, verifiable and agreed to, and that risks are understood.
2. **Work Breakdown Structure (WBS).** The behavior created by developing a work breakdown is *control* behavior. The WBS enables project team members to stand back and see how their part fits into the project as a whole, to see if any-

thing is missing, and how the project might be better organized or broken down further. An approach to controlling work is to divide it into smaller pieces and then to control the pieces. If the pieces are still too large and complicated, then those pieces are broken into yet smaller ones, and so on. There are many views and opinions on how projects should be broken down, and there are many different work breakdowns that are possible; however, the best work breakdown is that which will best *control* the work; that is, control of quality, schedule and budget.

3. **Project Organization.** The behavior created by developing a project organization is *accountability and ownership*. One individual's name should be associated with each task of the work breakdown. If an individual cannot be identified at the time of planning, the name of the line manager who will provide that individual to the team should be associated with the task. If there are tasks without names, what should be of concern is . . . *Who will define the objectives for these tasks?* If it is someone other than the one who will do the work, the probability of ownership of the work decreases and the probability of defects delivered to the customer increases.
4. **Project Schedule.** The behavior being created by a project schedule is communications across the project team, with company management and with customers. "The problem," says one expert, "is that our fascination with the tools of management often obscures our ignorance of the art." What comes out of a computer is often not usable and needs to be simplified. Some of the best schedules are simple and hand-drawn; those that fill entire walls often benefit only the person who developed them.

5. **Project Performance Baseline (Budget).** The behavior created by developing a project budget is to establish a performance baseline and, therefore, *control*. A performance baseline is a prerequisite for project control. People cannot work to their maximum effectiveness if they don't know what their goals are or how well they are doing in relation to these goals. An effective management action is to request that project team members develop their budgets as functions of time. The behavior created by this request is that they have to first break the work down into tasks, determine the various work products in each task, and then determine the interdependence of these work products that arranges the work products in time. This arrangement of work products in time represents a performance baseline used to control the work.

These five tools—Project Objectives, Work Breakdown Structure, Project Organization, Schedule and the Performance Baseline (Budget)—when taken together (often with additional company specific requirements), constitute the *Project Execution Plan*, a management tool used to create and foster planning behaviors. Although one cannot guarantee that appropriate planning is done, one can improve the *probability* that appropriate planning is done. Contractors and team members should be asked to develop a *Project Execution Plan* before their work is authorized. It should be requested in the Statement of Work (SOW) to be submitted in the contractor's proposal.

Leadership. There are three basic behaviors in project leadership: *communications, team building* and *empowerment*.

1. **Communications.** Well-run companies are characterized by their intense

communication across their organizations, between project team members, between the project teams and their customers, and between the project teams and their line management. Similarly, well-run projects nearly always have many informal communication paths among team members, management and customers. Building relationships with team members, customers and contractors is very important to the success of the project management method.

2. **Team Building.** Team building is action taken by the project manager, team members and line management that enables a group of individuals to better work, think and act jointly. Project teams spend a lot of time together, jointly setting group goals, exploiting positive feedback, recognizing and rewarding achievement, setting rules of behavior and establishing urgency, according to J.R. Katzenbach and D.K. Smith, writing in the *Harvard Business Review*.
3. **Empowerment.** An often overused word, empowerment refers to the project manager's actions to motivate team members toward attaining the customer's needs. As such, it requires an understanding of the team member, management and customer cultures, values and management styles. Team members are motivated by different things, including achievement recognition, advancement, responsibility, coworkers and management, and the work itself.

Control. Although project teams work largely on their own and are called self-controlled, they do not work in isolation. They need the support of an appropriate conflict resolution and feedback system. As part of the system, people set their own ob-

jectives, keep track of their progress, determine how their progress influences others, and establish appropriate responsive actions. The system provides checkpoints and feedback to prevent instability, ambiguity and tension in the company. At the same time, the system avoids rigid control that can impair creativity or spontaneity and drive the project out of control, vis-a-vis micro-management. The control system further involves the continuing behaviors of *measuring, evaluating* and *acting*.

Measuring is determining the degree of progress being made in the project. The metrics used to measure progress are determined during the planning process. The metrics should be true indicators of progress gathered so that they are statistically significant. Inappropriate measurement can drive the system out of control.

Evaluating is the process of determining causes for adverse performance deviations and predicting what can be expected in the future. It also involves determining possible ways to avoid or correct problems.

Acting involves communicating progress to appropriate people, taking actions to correct unfavorable trends, and taking advantage of opportunities.

For a company, project or task to be in control, the following three elements are prerequisites and must be present at appropriate levels in the organization. If inadequate, the company, project and/or task will be theoretically out of control:

- *Project execution plans.* What is being done to create planning behaviors at all levels in the company, projects and tasks? What is being done to foster appropriate planning behaviors in contractors and suppliers? Are such plans developed before work begins?

- *Procedures for analyzing, reporting and reviewing performance against base-lines.* Are there procedures for formal or informal feedback of performance information to project team members, to line management, to the customers? Are they appropriately designed to provide people the information they need to be in control? Do the customer and management have appropriate and timely information to support the project team? Do they make executive decisions for the company that only they can make on behalf of the project?
- *Disciplined process for considering, approving and implementing change.* A system cannot be in a constant state of change without proven, significant performance information as a basis for action. Actions taken to correct an already altered state can cause the project to be "out of control." The effect of the change must be allowed to stabilize in order to determine its true effect.

■ Teamwork

Cross-company project teams build quality into service to customers through cross-functional creativity and innovation, big picture participation, added value caused by cross-functional reinforcement of complementary styles, and value systems of team members. Project teams will become building blocks of future companies, and the organizations of these companies will be those that best support these teams. Project teams will direct and discipline their own performance and be in control through organized feedback and coaching by customers and the companies' management. This is the project management method. Its basic notions are not new. The method is becoming popular because it appears to work better than other systems.

■ For Further Reading

Bloom, Allan. *Closing of the American Mind*. Simon and Schuster, NY, 1987.

Deming, W. Edwards. *Out of the Crisis*. MIT, Cambridge, MA, 1982.

Drucker, Peter. *The Coming of the New Organization*. Harvard Business Review, No. 88105, 1988; *Management*, Harper & Row, NY, 1973.

Odiorne, George. *MBO II*. Fearon Pitman Publishers, Belmont CA, 1979.

Peters, Tom and Thomas Waterman. *In Search of Excellence*. Harper & Row, NY, 1982.

Career Development for Project Management

by Dr. Edward J. Hoffman, Dale Crossman,
Deborah Duarte and Andrea Lewis

NASA is experiencing dynamic change with a new emphasis on cost consciousness, increased participation with other government agencies, and more opportunities and requirements for international partnerships. Additionally, the explosion of scientific and engineering knowledge necessitates the pooling of resources from different disciplines, and capitalizing upon the synergy found in well-functioning teams.

These changes and the new skills needed by contemporary project managers present significant challenges to NASA concerning the management of its programmatic, technical and human resources. To address these challenges, NASA commissioned the Program/Project Management Initiative (PPMI) to develop leaders in project and program management. A study was initiated in the mid-1980s by the PPMI to identify the key requirements of NASA project and program managers. Many senior project managers participated in establishing the current educational curriculum. However, a foundation based on the current organizational environment was needed to continue building PPMI programs and activities. Thus, a full scale Career Development Research Study was launched to create an empirically based foundation for PPMI.

Although NASA Centers have implemented career development programs, some of which target project management personnel, an Agency-level program designed within the context of the strategic objectives of NASA and the PPMI was found to be necessary. Participation of NASA Centers' project personnel in the study helped to ensure the applicability of the career development program across the Agency.

Information was gathered from subsystem, system and project managers in NASA to determine what sequence of experiences, responsibilities, education and training are desirable, practical, or required at each point in a career progression. Specifically, this research resulted in four products:

1. Typical career paths of existing project managers.
2. Career recommendations at four distinct stages of professional development.
3. Requirements (knowledge, skills and abilities, experiences and other characteristics) for effective performance at the various levels.
4. Training and developmental experiences that are useful for subsystem, system and project managers.

General recommendations resulting from this study include the following. Entry level engineers and project workers should be involved in hands-on hardware, software and operations activities in a variety of areas. Subsystem and system level managers should have the opportunity to work on a variety of projects and to interface with outside organizations in order to gain a "big picture" perspective. Their training should focus on contractor management (including procurement regulations and contract preparation) and managing people. Project managers should be encouraged to place a heavier emphasis on developing their key people. Project workers at all levels should be encouraged to participate in training courses that cover basic

project management, administrative and interpersonal skills. They should also seek developmental assignments in both technical and resource management. Additional training programs or more modules in existing courses should be developed to address those requirements which are not met by the current curriculum. And finally, a formal development process for project managers should be developed to ensure an adequate skill base on project teams.

■ Career Paths

For this study, a career path is defined as a sequence of job positions and experiences which lead to a specific career level—in this case, the project, program or engineering manager level.

Two main paths and one secondary path exist—two paths through engineering and project organizations (the majority of the sample worked in one of these organizations) and one path through a program organization, respectively. A barometer of approximate years of experience held by interviewees for certain positions should be interpreted with caution. They should not lead an observer to conclude that they should attain a specific level job by a certain amount of years of experience.

Career levels describe the types of jobs held by interviewees, and were assigned using the following definitions:

- **Entry level worker**
Non-supervisory worker in first job with no previous experience
- **Mid-level worker**
Non-supervisory worker with 1 to 3 years of experience
- **Journey level worker**
Non-supervisory worker with 4 or more years of experience

- **Journey level worker**
Non-supervisory worker with 4 or more years of experience
- **Expert/master**
Lead technical expert with 10 or more years of experience; includes principal investigator
- **First line supervisor**
Section chief, group or team leader, or first position of leadership (10 to 20 years)
- **Middle manager**
Branch, deputy division or division chief, system or subsystem manager (15 to 25 years)
- **Upper manager**
Project manager, deputy director or director, assistant or deputy administrator, and all other senior management positions (20 to 30 years of experience)

For an entry level engineer, hands-on hardware development was the most frequently experienced responsibility. As one moves up the path in either an engineering or a project organization, one quickly takes on contractor management as a main responsibility. As one moves toward upper management in either engineering or projects, contractor management duties consume less time while project planning and advocacy become the main responsibilities.

The vast majority (about 75%) of senior managers started as entry level engineers in an engineering organization. A few began their careers in a project or program office, or in other organizations such as an administrative or operations organization. A large percentage of the sample started their careers at NASA, although a few began careers in either another government agency or private industry. By the middle career stages, the entire sample worked for NASA; no one in the sample entered NASA at an advanced career stage from outside.

Most interviewees migrated toward a project organization. Approximately half of the sample is represented in the top blocks under a project organization in Table 1 (see foldout). A significant number (35%) also remained in either an engineering or a program organization. A minority (15%) of interviewees moved back to an engineering organization after working in a project office, or moved back to a project office after working in a program office. Several lateral moves did occur. A worker would often move from one engineering job to another, or from managing one project to another.

■ Career Recommendations

For up-and-coming project managers, interviewees recommended job positions, associated responsibilities and general advice for four career stages. These results tend to be autobiographical, reflecting the career paths to some extent. Interviewees tended to recommend experiences which they followed. Since these experiences led them to the position of a project or engineering manager, it appears they deemed their choices as successful. However, these recommendations also illustrate the lessons learned and reflections on NASA's changing environment and culture from seasoned and respected interviewees and thus are directed toward the future.

Job positions for each stage include several alternatives. Accompanying the positions are responsibilities which interviewees considered to be integral to professional development. The order of responsibilities was determined by how frequently they were mentioned by interviewees. Advice was spontaneously given by interviewees throughout the interview process. Independent of the job positions and associated responsibilities, this advice lays out universal guidance for pursuing an active and successful career.

Stage I: Getting Established. For this stage, an engineering position was recommended by the majority of interviewees. The particular specialty of engineering does not seem to be important; broad experience is the key. The responsibility most closely associated with these positions is hands-on hardware experience. As one progresses through a career in project management at NASA, one will have increasingly less exposure to actual hardware, and will be managing hardware systems from a considerable distance. Therefore, familiarity with the design, building and testing of hardware early in one's career is essential.

Along with hands-on hardware work, general experience in all phases of the project life cycle is also recommended. Since a project manager serves as a generalist rather than a specialist, familiarity with the entire project process is important.

Activities involving communications are highly recommended, including writing reports and making presentations. Later on in this report, in the Job Requirements section, communication is described as one of the most important skills for a project manager. Experience in this area is therefore excellent preparation for a career in project management.

Since the future of the work place will rely on information technology, responsibilities involving computer tools are necessary. A vast array of new software has been produced to aid project managers in building and tracking schedules, budgets and tasks. Awareness and understanding of computer tools will enable one to remain current with state-of-the-art technology relevant to project management.

The advice given for this stage reflects its name *getting established*. Interviewees recommended that entry level workers seek a

breadth of experience, learn as much as they can from as many sources as they can, and work on developing a competent and trustworthy reputation. Interpersonal skill and teamwork were also mentioned. These skills are among the most important for a project manager, as described in the Job Requirements section. Establishing these skills early on is critical.

Stage II: Independent Contributor. Job positions in this stage are either lead technical experts or first line supervisors. They assume an established technical knowledge base and an ability to direct and manage technical work.

Contractor management and technical oversight were overwhelmingly mentioned by interviewees as key responsibilities during this stage. NASA's heavy reliance on contractors necessitates time consuming administrative activities and effective integration of contractor activities with in-house work. This integration concerns technical as well as interpersonal issues.

Budget and schedule management are integral to the management of projects; both have received increasing attention and scrutiny. Responsibilities in these areas are quickly gaining importance. Some hands-on technical work (i.e., hardware design and testing) is still encouraged. Outreach activities such as public relations and meetings with outside groups begin to be a part of one's major responsibilities.

The advice in this stage reflects the transitional role of workers who are moving from a technical position to that of a manager. Continuous development of expertise is recommended. However, emergence as an overseer is strongly encouraged. Visibility can be achieved through many avenues—making presentations, attending meetings and working on critical assignments. Tak-

ing risks is part of becoming independent and shows initiative. Pursuing educational opportunities such as degree programs and Agency training courses indicates that a furthering of one's career must be accompanied by conscious effort for redirection.

Stage III: Technical Lead/Manager. Job positions in this stage are mostly managerial, yet they still contain variety. A worker in this stage could be managing a system or subsystem of a spacecraft, managing costs of a project as a program controller, or managing technical experts in an engineering organization as a section or branch head. Only one position mentioned, chief engineer, serves as a technical expert.

Responsibilities in this stage are very similar to those in Stage II—contractor management, technical oversight, and general project management. The difference is that the degree of responsibility is increasing. Preparation for major events such as project reviews and launches appears as an integral part of one's job. These responsibilities reflect an emergence of the global nature of a project or engineering leader.

The advice in this stage reflects the evolution of more extensive responsibilities—developing a big picture perspective and interfacing with groups outside of NASA. Technical expertise is assumed to have developed by now. Familiarity with higher level activities and serving as Center and Agency liaisons will provide the seasoning necessary to move into the fourth career stage. Lateral moves were recommended as a vehicle to gain diverse experience.

Stage IV: Organizational Sponsor. Job positions for this stage reflect responsibility for entire projects, programs or organizations. They entail not only management of internal technical and human systems, but outreach, advocacy and leadership.

Career Paths for Project Management

Engineering Organization

Project Organization

Program Organization

Branch Head Project Manager

- ▶ Project management, planning
- ▶ Project advocacy
- ▶ Represent Center
- ▶ Establish policy

Manager (Technical, Contract, Subsystem) Analyst (Thermal, Data)

- ▶ Design (hardware, space systems, power systems, vacuum systems, propulsion systems)
- ▶ Testing flight hardware
- ▶ Contract oversight
- ▶ Requirements definition
- ▶ Analysis (mission, spacecraft)
- ▶ Research, conducting studies
- ▶ Project definition and planning
- ▶ Cost estimating

Engineer (Instrument, Mechanical, Aerospace, Design/Development, Test/Evaluation, Power Systems) Analyst (Thermal, Data, Flight Performance, Systems)

- ▶ Hands-on hardware development
- ▶ Analysis (data, spacecraft, thermal, trajectory)
- ▶ Testing (wind tunnel, data, requirements, mechanical systems, spacecraft equipment)
- ▶ Computer programming
- ▶ Design (solid motor, power systems, logic, mechanical systems, advanced mission)
- ▶ Understanding and defining requirements
- ▶ Research, conducting studies
- ▶ Writing specifications, procedures, technical papers

Project Manager Associate Director

- ▶ Budget/program development and planning
- ▶ Division planning
- ▶ Project advocacy
- ▶ Contractor management

Project Manager Senior Project Engineer Systems Engineer

- ▶ Contractor management
- ▶ Analysis (test & schedule, thermal, mission)
- ▶ Review and coordinate design activity
- ▶ Project planning, integration and coordination
- ▶ Requirements development

Integration Manager

- ▶ Systems engineering
- ▶ Management (project, contract, new contract oversight, project planning, technical)
- ▶ Coordinate and review designs
- ▶ Analysis (data, mission, subsystem, test and schedule)

Program Manager

- ▶ Budget development
- ▶ Internal, external advocacy (project, program)
- ▶ Strategy development

Program Manager Chief, Advanced Programs Development

- ▶ Program management
- ▶ Negotiations

LEGEND

- ▶ Most Common Paths Approximately 50%
- ▶ Common Paths Approximately 35%
- ▶ Less Common Paths Approximately 15%
- ▶ Lateral Moves

20-30 Years Upper Manager

0 Years Entry Level

WITHOUT FRAME



Project control and oversight, mentioned by an overwhelming majority of interviewees, encompass many activities, all of which are of a global nature. A worker at this stage is mostly removed from the day-to-day technical arena. Contractor management, budgeting and scheduling, while still significant responsibilities, consume relatively less time. Setting goals and objectives, generating plans and formulations, and defending major decisions and requests make up the largest part of one's job. Attention to people is also of utmost importance. Motivating and developing employees are integral to project success, and they become the responsibility of top management. Other responsibilities that were mentioned (chairing reviews, making presentations and negotiation) all indicate the advocacy nature of this stage.

The advice for this stage includes seeking responsibility for managing a major project, which is the essence of a project manager's job. The key word is "major"—large projects often bring visibility. Mention of visionary leadership indicates having foresight and mobilizing resources to prepare for the future. Finally, developing key people is recommended in order to strengthen the work force continuously and to ensure a successful future for the Agency.

■ Job Requirements

Job requirements are the knowledge, skills and abilities, experiences and other characteristics which underlie effective job performance.

Job requirements are reported for subsystem, system and project managers. Subsystem managers include workers who had responsibility for managing a defined portion of a physical system. System managers include workers who manage a larger portion of a physical system. Project managers

include workers managing formal projects, as well as upper level engineering managers who are highly involved in the project arena. Definitions of each of these job levels may vary by Center.

The job requirements for subsystem, system and project managers are listed in the order of how frequently they were reported by interviewees; those high on the lists were reported more frequently than those which are lower on the lists.

The job requirements reported by subsystem, system and project managers mirror the responsibilities and advice obtained for the four career stages described in the previous section. In summary, system and subsystem managers report the necessity of mostly technical knowledge, the need to act independently, to take initiative, and the ability to admit lack of knowledge or skill in order to learn and develop. They also cite a diversity of experiences as influential in becoming successful. This reflects the responsibilities and advice given for earlier career stages. Project managers report a heavy emphasis on understanding the political environment and gaining experience with outside groups and organizations, reflecting the global nature of responsibilities mentioned in Stage IV: Organizational Sponsor. The fact that the requirements reported by subsystem, system and project managers reflect the hierarchy of responsibilities and advice for the four career stages lends validity to the findings.

Despite the differences in responsibilities at different career stages, requirements reported for all three groups are very similar. Although workers at earlier levels emphasized technical knowledge more than project managers did, all three groups reported that interpersonal skills are necessary for successful project management. Technical skills are reported as secondary.

Knowledge. Knowledge mentioned by subsystem and system managers was overwhelmingly technical, specifically relating to hardware and technology. Project managers mentioned the political environment as the most important kind of knowledge for their jobs. This outcome complements the finding that advocacy and outreach are among the project manager's chief responsibilities. Although technical knowledge is a basic necessity, political wisdom is imperative.

Skills and Abilities. Teamwork, communication and managing people were reported by an overwhelming majority of interviewees in all three groups. Furthermore, interviewees included in the definition of *team* not only those directly reporting to them, but members of Headquarters, top management, procurement and contractors as well. These interpersonal skills were mentioned in much greater frequency than any technical skills.

Communication. Broad communication skills are integral to building an effective team. These skills are often overlooked since little formal training is usually received. Clear, precisely written documents (e.g., statements of work, requirements) are crucial to successful projects. Communication of current events and problems are critical in overcoming obstacles, which are always plentiful. Finally, communicating the big picture to employees is important in enhancing their contributions to the overall project.

Planning. Planning in all areas was given much emphasis. The need for up-front planning and its ability to save costs and avoid problems later was stressed. Contract management, as mentioned earlier, is skill key in an Agency with high contractor involvement. The remaining skills and abilities reported by all three groups in-

clude program control (cost estimating and scheduling) as well as general management activities such as problem solving and conducting effective meetings.

Experience. Subsystem managers emphasized the importance of a diversity of experiences that involve hands-on hardware development. They also indicated the need to carry some technical leadership in order to advance one's career. Experience for system managers focuses on obtaining broad experience primarily through rotation programs. Specific experience in flight projects was mentioned as a key activity. Experience for project managers addresses the diverse activities needed to prepare for global responsibilities.

Other Characteristics. Subsystem managers indicate the need to act independently and seek increasing levels of responsibility. The characteristics most frequently mentioned by all three groups were accountability, responsibility and ownership; a project manager must avoid placing blame on others and be willing to share credit for successes. All of these characteristics are not easily developed through training, but are either innate traits or cultivated through socialization and experience. Furthermore, these characteristics were perceived as an ideal for project management workers at all levels; reality often falls short of this model.

■ Training and Developmental Experiences

All three groups reported that experience is critical to developing strong and useful knowledge, skills and abilities. Similar to the recommended job responsibilities cited in the Getting Established and Independent Contributor career stages, assignments in a variety of disciplines and projects was deemed as beneficial.

All three groups reported that management support of training was important to their development. Managers who offer support and who value training are integral to developing NASA's work force. Managers who give employees autonomy and the opportunity to excel tend to promote worker ability and confidence. Finally, respondents expressed appreciation for senior managers who act as mentors.

Job Requirement Drivers. For this study, a job requirement driver is defined as an aspect of NASA that facilitates the development of the knowledge, skills, abilities and experiences described in the previous section. In other words, a driver enables a worker to acquire the knowledge and skills which will lead to successful job performance and advancement.

Subsystem, system and project managers described NASA culture and management as sometimes acting as restraining forces. Parochialism and competition among Centers, unclear roles and responsibilities, plus a lack of use of project management tools were cited as barriers to development and career progression. A lack of formal career paths was particularly mentioned as a problem. Concerning management practices, unfair reward and recognition procedures, as well as a lack of mentoring, were related as being obstacles. Finally, lack of time and budget for training courses was mentioned as an impediment.

Valuable Training and Programs. The interviewees were asked which types of training and developmental experiences helped them develop the job requirements described previously. All three groups reported that on-the-job training and experience was most essential. Specifically, hands-on hardware experience and participation in interdisciplinary and inter-Center teams was mentioned as valuable.

Several formal training opportunities were cited as beneficial. These include courses in project management, procurement, and personnel; Agency programs such as the Management Education Program and The Human Element; and rotation programs such as Headquarters' Professional Development Program and Goddard's Professional Intern Program. Such an array of endorsed courses illustrates the utility and significance of technical and managerial training.

Needed Training and Programs. Interviewees were asked to report the types of training and developmental experiences that need greater participation and more frequent offerings. All three groups assert that on-the-job training should be coupled with formal courses in order to realize the maximum benefit for professional development. Similar to responses to the previous question described above, interviewees stressed the importance of experience in a variety of disciplines and projects.

The training courses mentioned by interviewees included topics specific to project management, such as cost estimating and performance measurement, but also topics which have universal applicability to all fields. These include writing, oral presentations, computer tools and time management. These results support the notion that a successful project management worker must not only be technically proficient, but administratively and interpersonally competent as well.

Finally, system and project managers urged the creation of a recommended, sequenced curriculum for project managers. This type of structured curriculum would enable up-and-coming project workers to obtain appropriate training and would permit NASA to cultivate a fully developed, maximally effective work force.

Formal Education. Subsystem, system and project managers were asked to report the level of formal education needed to effectively perform their jobs. All three groups reported that a bachelor's degree in a technical field (usually engineering, but possibly math or science) is necessary. An advanced degree (Master's) in either a technical discipline or in management (e.g., Public Administration or Engineering Management) is helpful but not essential. Interviewees asserted that on-the-job experience must be coupled with formal education to achieve maximum benefit.

Project Management Requirements Covered by Existing NASA Courses. Topics in the areas of planning, scheduling, cost estimating and program control

are covered at an appropriate level. Technical topics such as hardware design, operations research and mission operations are not covered in detail in the standard curriculum, but are available at local colleges, universities and at special courses sponsored at the Center level.

The areas that need special attention appear to be building project advocacy and managing the NASA political environment; skills related to building a team, communication, creative problem solving, delegation and leadership; and understanding the NASA personnel system. The Program and Project Management Initiative will study the feasibility of realigning the curriculum to incorporate these findings.

Resources for NASA Managers

by William M. Lawbaugh

■ Project Management Resources on the Internet

Many resources on the Internet are of value and interest to the project manager, including files of the National Performance Review and discussion lists devoted to TQM, ISO 9000, Training and Development. The Internet also offers project management personnel at various NASA Centers a quick and easy means of communicating. A new Program/Project Management Initiative (PPMI) Listserv has been created to:

1. Act as a forum for the project management community to share questions, suggestions, lessons learned and other information in a convenient fashion.
2. Provide schedule information about NASA PPMI training and other relevant news of interest to the PPMI community.
3. Offer widespread dissemination of information from the Program/Project Management Librarian, including subject bibliographies and listings of new resources available on the Internet.
4. Address the information needs of the PPMI community and offer a conduit for those needs.

NASA employees and contractors have a wide range of Internet experience. Some are Internet experts and will only need an address in order to access that resource; others will require more help. The following is a compromise between the minimum use of technical jargon while still offering

some basic instruction on navigating Internet resources. Please refer to your Center library's collection of Internet books and journals for more information. One good recent article on the topic is in the August 1994 issue of *Training & Development* by Bryndis A. Rubin entitled "The Internet: Where Few Trainers Have Gone Before."

Information of interest to the PPMI community may be found on listservs and bulletin boards, at World Wide Web and Gopher sites, and through Archie and Veronica searching. The method you use is less important than knowing where the information is located.

The PPMI list has been created exclusively for the NASA project management community; those outside NASA will not be able to subscribe. If you are with NASA but do not have nasa.gov as part of your e-mail address, contact the PPMI Librarian to discuss how to join the list at (202) 358-0172.

All NASA readers of this article are invited to subscribe to this list; the method is similar to most other lists to which you may have subscribed. To subscribe to the PPMI Listserv, address your message (with nothing on the subject line) to:
domo@hq.nasa.gov

The message should read:
subscribe PPMI

Listservs/Discussion Lists. An easy way to discover new things is to subscribe to Internet listservs, which are discussion groups devoted to particular topics. Once subscribed you can join in on discussions, or sit back and "lurk" as you learn what

the list is all about. For example, if you subscribe to the ISO 9000 list, you will quickly learn additional sites for information in that area as questions abound from subscribers.

Some sample lists follow. Please remember that these addresses are current as of late 1994 and could become quickly out of date. As new lists may be created at any time, one purpose of the PPMI Listserv is to advertise new discussion lists as we find them. Lists are as easy to leave as they are to join, so feel free to sign up for any that appeal to you.

ISO 9000. This discussion list is devoted to the ISO 9000 series of quality standards. To subscribe, send the following message with the subject line blank to:

listserv@vm1.nodak.edu
subscribe ISO9000 yourfirstname
yourlastname

Example:

subscribe ISO9000 jeffrey michael

Quality (TQM in Manufacturing and Service Industries Discussion List). This list covers many aspects of TQM, and is intelligently moderated to keep the discussion organized. Since list members include company practitioners of TQM, academics and book and magazine writers, the discussion is varied. To subscribe, send the following message with the subject line blank to:

listserv@pucc.princeton.edu
subscribe quality yourfirstname
yourlastname

Business Process Redesign/Reengineering (BPR). This mailbase discussion list was created by academics in the United Kingdom to create cross-disciplinary discus-

sions of BPR issues. Subscribers are diverse in their professions and nationalities. To subscribe, send the following message with the subject line blank to:

mailbase@mailbase.ac.uk
join BPR yourfirstname yourlastname

REGO/NPR (Reinventing Government/National Performance Review). Several lists have been created devoted to Reinventing Government (REGO) issues. To subscribe to the original list, REGO-L, send the following message with the subject line blank to:

listserv@pandora.sf.ca.us
subscribe REGO-L yourfirstname
yourlastname

Spinoffs from the original list include REGO-QUAL (Creating Quality Leadership and Management in Government) and REGO-ORG (Organizational Structures in Government). These lists are not yet as good as the original, and have too many George Mason University students as subscribers since George Mason is the home site. To subscribe, send the following message with the subject line blank to:

listproc@gmu.edu
subscribe REGO-QUAL yourfirstname
yourlastname
subscribe REGO-ORG yourfirstname
yourlastname

Training & Development List (TRDEV-L). This list is devoted to the interests of the training and development community from many different organizations. To subscribe send the following message with the subject line blank to:

listserv@psuvm.psu.edu
subscribe TRDEV-L yourfirstname

Professional Organizational Development (POD). Those interested in POD may want to take a look at this discussion list. To subscribe send the following message with the subject line blank to:

listserver@lists.acs.ohio-state.edu
subscribe POD yourfirstname yourlastname

World Wide Web and Gopher Sites. Do you want copies of NPR reports, selected MIL-STDs, SF171 software, or other Federal information? The Internet offers several methods of downloading such information. For World Wide Web (WWW) sites you need a Web browser (Mosaic is one example), which should be available at all NASA Centers. Some interesting addresses include the following, which are case sensitive, so please use the addresses as they are written:

Malcolm Baldrige National Quality Award information: (please send as one line):

http://www.nist.gov/item/NIST_Malcolm_Baldrige_National_Quality_Award.html

This site offers criteria for the Baldrige Award, a list of past winners, and other related information.

National Performance Review (NPR):

<http://WWW.NPR.GOV>

This new site includes a Reinvention tool kit, and offers a soundbite of Vice President Al Gore speaking on the NPR.

Americans Communicating Electronically (ACE):

gopher ace.esusda.gov

This is another way to download all the reports of the National Performance Review.

You may gopher to the address above, or to get a list of all NPR reports you can download, send the following message with the subject line blank to:

almanac@ace.esusda.gov
send netresults catalog

W. Edwards Deming files at Clemson University:

<http://deming.eng.clemson.edu>
<gopher://deming.eng.clemson.edu>

This university Gopher/Mosaic site is definitely worth some exploring. It includes downloadable TQM files, public domain software and offers a tool for searching the CQI server.

Bulletin Boards. Bulletin boards are another format for discovering a wide variety of information, including the downloading of files. Almost every government agency has an electronic bulletin board, and one good way to access them all is through FEDWORLD, the NTIS gateway system. FEDWORLD may be accessed by modem at 703-321-8020 or by telnetting to:

fedworld.gov

Follow online instructions to register. Resources for downloading include MIL-STDs, NPR documents and other Federal information. FEDWORLD also serves as a gateway to the bulletin boards of many Federal agencies; see the Gateway section of the FEDWORLD main menu for a list of those bulletin boards.

OPM Mainstreet is accessible through the gateway system as #44. Resources include a listing of Federal jobs, NPR files, downloadable software (including SF171) and a section devoted to TQM events and discussion.

The TQM BBS is accessible through the FEDWORLD gateway system as #68, or by modem at 202-606-4800. This bulletin board offers additional information on total quality and related issues. All of our Program/Project Management Resource Lists are available at that site as PPM.ZIP. (Contact your local computer help center for information about unzipping files.)

This is just a sampling of all the information available on the Internet. Contact the PPMI Librarian at NASA Headquarters with additional information you have found, or if you have any questions about the lists or bulletin boards.

Some Internet problems may require the help of your systems personnel. The PPMI Listserv will serve as a means of organizational learning on this topic, as we share our discoveries of Internet resources. Communication throughout NASA will be as easy as sending an e-mail message when you subscribe to the PPMI list.

■ Book Reviews

Training for Profit: A Guide to the Integration of Training in An Organization's Success
by Philip Darling (McGraw-Hill, 1993)

This is only one in a dozen or so books in McGraw-Hill Europe's training series. Philip Darling is a trainer and lecturer at the Roehampton Institute in England, but he appears knowledgeable of the American scene. He notes, for example, that half the companies listed in the Fortune 500 for 1955 dropped off by 1980; by the late 1980s, however, the dropout rate accelerated threefold. In addition, only 14 of the 43 companies identified as "excellent" by Tom Peters in *In Search of Excellence* (1982) could still be regarded as such just

five years later. An official of IBM Europe is quoted by Darling as saying: "For it seems to me that in practically every sector of the economy, the dynamics of competition are shifting away from the industrial logic of the past to the service-driven philosophy of the future."

Building on that insight, Darling says the implications for training include not merely adjustment to increased competition and a faster rate of technological change, but a whole new mindset. Training must now be regarded as continuous and perhaps even a lifelong process. Specifically he recommends emphasis upon the following:

- *Quality.* "TQM is a 'people' issue," he notes, "rather than a technical one," requiring a heavy investment in education and training for quality throughout the organization.
- *Just-in-time working.* "The essence of JIT is that production is 'pulled' through the organization according to [customer and market] demand, rather than 'pushed' in accordance with rigid production schedules."
- *Teamworking.* Employees should be trained to take responsibility for organizing some if not all of their own work as a team, with a shared goal. Emphasis shifts from supervision to "self-help, problem-solving and cooperation."
- *Problem solving skills.* Training in informational technology leads naturally to better cooperation and teamwork in solving problems, especially with desktop personal computing.
- *Organizational learning.* Managers today "need to be skilled in unlocking the talents of their staff and helping them learn how to learn," Darling concludes.

A learning organization encourages "a climate of continuous learning and development in which people can grow."

After all, the author proclaims at the very start of his 155-page paperback, "the long-term success or failure of any firm depends upon the quality of its work force." Training, education and development are not one-shot efforts to fix a problem but rather continuous solutions for the growth, health and renewal of an organization in a period of rapid change.

Project Management: Engineering, Technology, and Implementation
by Avaham Shtub, Jonathan F. Bard
and Shlomo Globerson
(Prentice-Hall, 1994)

The authors of this 634-page textbook are experienced in electronics, information services and aerospace industries. Shtub and Bard teach industrial engineering at Tel Aviv University and University of Texas at Austin, respectively, while Globerson teaches in the school of business administration at Tel Aviv University.

As a textbook, *Project Management* takes the student from conceptual design through production and termination, using a class project to design and construct a thermal transfer plant (solid waste disposal facility).

This is not an engineer's text but rather a senior-level or first-year graduate course combining project management and engineering economics. Although the authors claim they rely on "simple models" and "avoided detailed mathematical formulations and solution algorithms," most students trained only in business administration will find some of the tools difficult, if not exasperating.

The authors also recommend *Project Management* as a handbook or reference for professionals in the field. As such, the book opens with engineering economic analysis and goes into basic checklists and scoring models. Then they analyze multi-attribute utility theory (MAUT) and the analytical hierarchy process (AHP), followed by organizational and work breakdown structures for the project manager.

Chapter 6 attempts to integrate total quality management into configuration management and control. More traditional tools such as Gantt charts, critical path method and the PERT approach follow the network models of AOA/AON (activity-on-arrow and activity on node). For R&D simulation, the authors introduce an advanced (Q) version of the graphical evaluation and review technique, called Q-GERT. They close with advice to not only evaluate the ongoing project but also conduct a postmortem analysis to achieve continuous improvement from project to project.

Project Management also comes with a demonstration disk (DOS) for a software system known as Super Project Expert. This educational version obviously contains only a portion of the \$695 version from Computer Associates, but it does give a 50-task limited glimpse of the software on disk and in an explanatory appendix.

Lest the project manager get bewildered or discouraged with all the charts, graphs and tables in *Project Management*, the authors reprint the "Laws of Project Management" from the American Production and Inventory Control Society:

1. No major project is ever installed on time, within budget, or with the same staff that started it. Yours will not be the first.

2. Projects progress quickly until they become 90% complete, then they remain at 90% complete forever.
3. One advantage of fuzzy project objectives is that they let you avoid the embarrassment of estimating the corresponding costs.
4. When things are going well, something will go wrong.
 - When things just cannot get any worse, they will.
 - When things appear to be going better, you have overlooked something.
5. If project content is allowed to change freely, the rate of change will exceed the rate of progress.
6. No system is ever completely debugged. Attempts to debug a system inevitably introduce new bugs that are even harder to find.
7. A carelessly planned project will take three times longer to complete than expected; a carefully planned project will take only twice as long.
8. Project teams detest progress reporting because it vividly manifests their lack of progress.

Despite the interactive computer programs, the vast engineering science and the hundreds of management tools that go into project management today, the eight "Laws" are comforting to remember.

Implementing Concurrent Project Management
 by Quentin C. Turtle (Prentice-Hall, 1994)

The author is president of Technology Management Group, a consulting organization, and adjunct professor in the college

of engineering at the University of Rhode Island. Having taught a course in technical project management for several years, he wrote a textbook on an increasingly hot topic. Turtle defines concurrent project management as concurrent engineering plus marketing, finance, purchasing, engineering, manufacturing and human resources functions, all in a team-building process. He uses the DoD definition of concurrent engineering: "A systematic approach to the integrated, concurrent design of products and their related processes." In a schematic chart (below), Turtle describes it as a hierarchy of organizations and cross-functional teamwork.

The bulk of the 213-page textbook is devoted to concurrent planning and concurrent scheduling. "Cost" receives only 10 pages, mostly tables and charts. His explanation of a 200-word summary report takes just about 200 words. He ends with a fine chap-

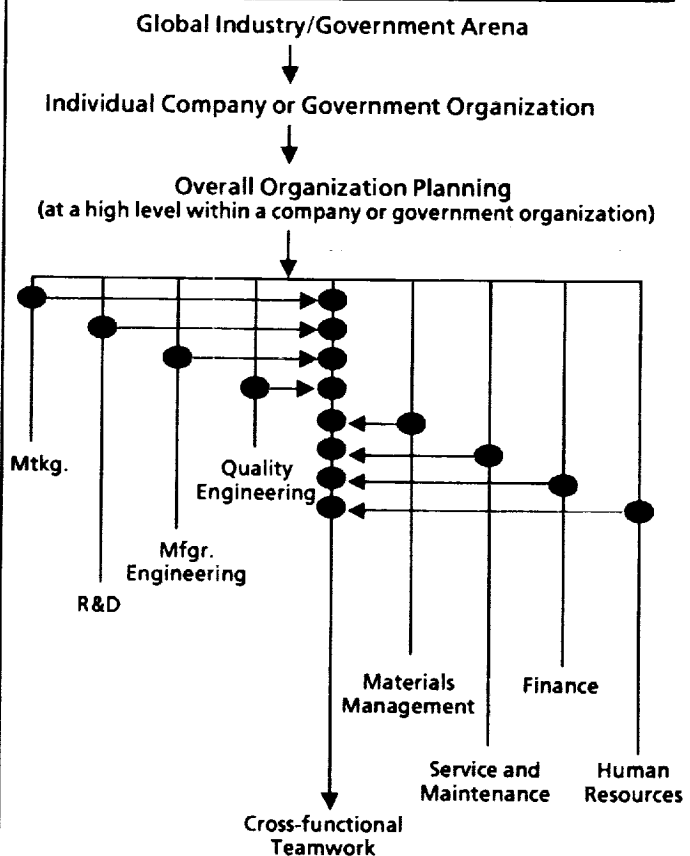

ter on Concurrent Control, emphasizing the need for "detailed, accurate, realistic planning at the outset."

In the preface, Turtle states: "This book provides the reader with the basis for Total Quality Management (TQM) in product development," but less than a page is devoted to TQM in the main text. Nevertheless, the book does apply fundamental concepts such as the PERT chart to such personal projects as purchasing a car or building a home.

The Wiley Project Engineer Desk Reference

by Sanford I. Heisler
(John Wiley and Sons: New York, 1994)

Subtitled "Project Engineering, Operations, and Management," this handbook covers a wide range of activities, including schedule development and control, materials acquisition, contracts and engineering organization.

A Project Manager (PM) is commonly the head of a task involving more legal, accounting and materials acquisition, but a Project Engineer (PE) is the head of a project that involves mainly engineering, says Sanford Heisler, PE. Thus, the emphasis here is on technical rather than managerial principles.

Nevertheless, the *PE Desk Reference* is a handy book of 500 pages, chock full of sample diagrams, flowcharts, standard forms and computer-generated tables. The many sample reports and outlines are quite useful and can be easily adapted to the needs of the project manager. Key terms and difficult concepts are highlighted in boldface and cross-indexed.

The desk reference is rather weak on computer technology but does include a long re-

port from ICF Kaiser Engineers on integrated project management control systems, more descriptive than prescriptive. Common sense prevails, though. Heisler warns against the proliferation of bewildering charts and analyses, and at one point discourages the use of indiscriminate e-mail.

The author suggests that most meetings are a waste of valuable time but does not go one step further to recommend teleconferencing or VITS as an alternative. He highly recommends training in time management and memory improvement, and he vigorously applauds the use of newsletters in any unit of 30 or more employees.

While the desk reference is heavy on construction and architecture, and thin on business and human resources, it is readable and useful. It is especially good on avoiding pitfalls in planning as well as contract negotiations.

Punished by Rewards

by Alfie Kohn (Houghton Mifflin, 1993)

Younger NASA project managers will remember writer-lecturer Alfie Kohn from his lively talk on "Competition and Cooperation" at the first Executive Project Management Colloquium in 1991 at Hampton, Va. The author of *No Contest: The Case Against Competition* (1987) told the delegates: "Rewards are offered in a controlling way." Incentives are a bad idea. They prompt people to cut corners, finish too quickly and take few risks. Furthermore, working for rewards is less pleasurable and less satisfying than working for self-motivated intrinsic rewards. People feel manipulated, controlled and less autonomous when rewards or incentives are dangled in front of them. These controversial and disputed notions are developed and explained in Alfie Kohn's latest book, subti-

tled "The Trouble with Gold Stars, Incentive Plans, A's, Praise, and other Bribes."

In a heavily documented tome with 65 pages of notes and 30 pages of references, Kohn traces our fixation with rewards to behaviorism, a semi-determinist theory of culture popularized by psychologist B. F. Skinner. Kohn deplors any attempt to reward behavior in the workplace and classroom as well as the home in childrearing, but he gives fair play to opposite views in two appendices by presenting a 1983 interview he had with Skinner and counter-arguments from current behaviorists.

Alfie Kohn stresses "intrinsic motivation" over being Skinner-boxed by rewards. In the workplace, he says, "the *desire* to do something, much less to do it well, simply cannot be imposed." All we can do is set up certain conditions that will maximize the probability of their developing "an interest in what they are doing and remove the conditions that function as constraints," such as merit pay and annual performance appraisals. Setting of salaries is not clear, but his notion of self-motivation is clear in the chapter title: "Thank God It's Monday."

"Hooked on Learning" is his chapter title on schooling. Kohn sees grades as degrading and instead proposes Three C's: collaboration, content and choice. Tell that to the typical harried and overworked schoolteacher.

"Good Kids without Goodies" is much more realistic but also quite difficult to achieve, because Kohn's effort to raise caring kids will take time. First, you must be genuinely caring yourself, a model for the child. Then you need to offer repeated opportunities to care for others, such as the aged or infirm. With bad behavior the parent is to assume positive motives but explain things over and over until the child (or teenager)

understands, or at least until their eyes stop glazing over.

Punishing by Reward is a fascinating book, an excellent follow-on to the Executive Project Management Colloquium.

The Project Manager's Desk Reference
by James P. Lewis
(Chicago: Probus Publishing Co. 1993)

This is an odd book, but one that is very useful for project planning, scheduling with CPM and PERT, program control and problem-solving.

It is odd because chapters and topics seem to stand alone, with little or no overall coordination. For example, the author deplors both CPM and PERT techniques in an introductory chapter as being old, static and unworkable "in a lot of situations," yet he devotes four chapters to them. He praises Peter Drucker for his focus on the customer and Peter Senge for "learning organizations" in the introduction but doesn't even mention them in the main text.

If there is a theme to *The Project Manager's Desk Reference*, it is stated as "concurrency." Lewis even coins the term "concurrent project management" in the introduction, but it is merely mentioned a single time in the main text. And if he introduces a project management hero, it is Dan Dimancescu, but his 1992 book, *The Seamless Enterprise: Making Cross Functional Management Work*, is not listed in the 50 pages of bibliography.

One chapter, on "progress payments," is taken from another Probus book, and another, on "strategy and tactics," is taken from an article in Sloan Management Review by Slevin and Pinta. Their Project Implementation Profile (PIP) is examined in another chapter by a college professor. One

chapter ends with "References," another with "Endnotes" and the whole book with "References" again.

Despite the flaws, *The Project Manager's Desk Reference* is best when the author, formerly in product development, compiles lists and checklists. For example, he lists 15 pieces of project scheduling software, with the address and phone of the manufacturers, and a general price range, plus an evaluation checklist, but no actual evaluation of any of the programs.

Lewis also believes that project management is the wave of the future in American business. He lists eight non-credit project management training institutions / consultants (including himself), nine undergraduate programs, and three graduate programs in project management. However, the curricula of Golden Gate University, Keller Graduate School of Management, and Western Carolina University resemble graduate school programs in business and finance more than the management knowledge and skills listed by the author as "primary."

The book ends with a chapter on "Sociotechnical Systems and Project Organization" which, again, fails to connect well with previous chapters. Nice illustrations done by his wife complement such topics as "joint optimization" and "cross-function management," and then a few extra pages on "personal premises" and "transformed behaviors and beliefs." How these topics relate to project management is not clear.

The Handbook of Project-Based Management

by J. Rodney Turner
(McGraw-Hill: London, 1963)

Yet another new project manager's handbook is a bit more dry and academic than

the others, but more comprehensive with more than 500 pages of text, charts and analysis.

Turner is a professor and consultant at England's famous Henley Management College in Berkshire. He abandons the traditional cost-performance-schedule triangle as being work done for its own sake in favor of a diamond of time (measured by CPM or PERT), cost/schedule control systems (managed by WBS), quality (TQM) and scope (SOW). He then adds another: the management of organization (resources, facilities and communication). In sum, here's what Turner's "structural approach" to project management looks like:

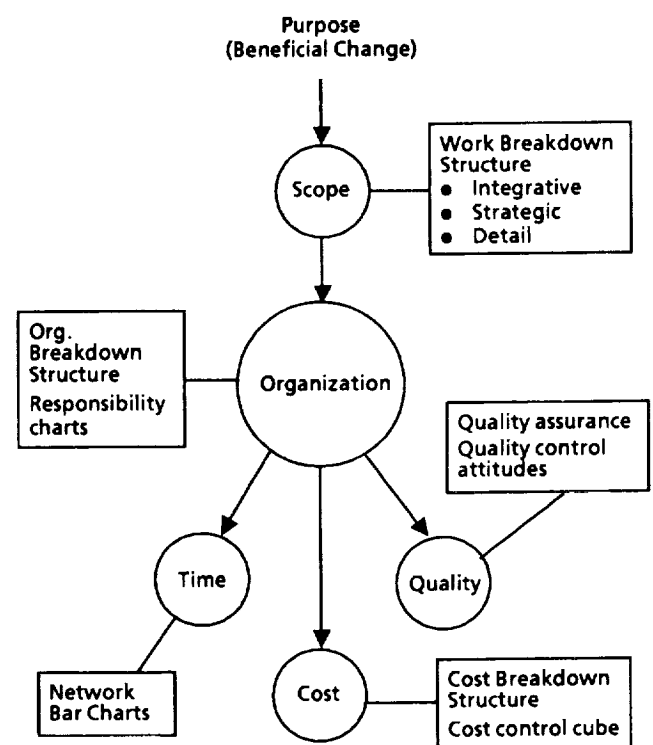

Some of the concepts, tools and categories may overlap in his scheme, but then the entire handbook is redundant, with many of the same topics covered chapter by chapter. Each chapter even has a topic outline summary.

Turner's "five principles of good project management" include:

1. Manage using a structural work breakdown.
2. Focus on results.
3. Balance objectives through the breakdown structure.
4. Negotiate a contract among the parties involved by trading benefits for contributions.
5. Adopt clear, simple management reporting structures; one page when possible.

The main idea of *The Handbook of Project-Based Management* seems to be this: even the most detailed and complicated tasks can and should be broken down into manageable portions and then executed. However, that leaves little room for creativity, serendipity or flexibility. The book itself is cut and dried, not for casual reading but fine as a reference book.

Scuttle Your Ships Before Advancing

by Richard A. Luecke

(New York: Oxford University Press, 1994)

History and *story* share the same Latin root, so business book editor Richard Luecke presents a half-dozen stories of entrepreneurs and opportunists in history to show lessons in leadership in a book subtitled "Other Lessons from History on Leadership and Change for Today's Managers." Luecke was inspired by Clemens and Mayer's *The Classic Touch: Lessons in Leadership from Homer to Hemingway* (1987) but uses history instead of literature to tell stories of business leadership. Of course, chronicles and biographies often paint their

historical figures larger than life, much like epic literature, so the examples of leadership are idealized somewhat.

One idealized character was Cortez, subject of the book's odd title. Cortez exemplified what Sun-tsu had theorized much earlier: that soldiers without an escape route would fight "with the courage of despair." Cortez, on route to the Aztec gold of Montezuma II in 1517, scuttled his ships before advancing. His 400 troops were thus committed to conquest or death, no turning back. For awhile, at least, the godlike conquistadors with their strange horses ruled over hundreds of thousands natives. For Luecke, this teaches daring and risk-taking.

A century before Cortez, French King Louis XI, described as a "change agent," was the first advocate of "management by (riding) around," and practiced what Japanese car makers learned but GM's Ross Perot did not: "to attack aggressively only those situations when the odds are clearly in your favor; and when you have your opponent on the run, do not let up."

Timing is everything, as we read in the case studies of Martin Luther and W. Edwards Deming. Their ideas struck a responsive chord; these outriders had ideas whose time had come. So, too, the ideas of Sam Adams, but not those of the British king's envoy at the time of the Stamp Act. Emperor Hadrian's ideas of global management are said to have hatched the Holy Roman Empire and live on the bipolar Vatican-missionary structure of the Roman Catholic Church. Innovative self-renewal under strong leadership saved the underdog British foot soldiers and archers from the powerful French mounted knights in 1346, as it saves behemoths like Motorola, 3M, Hewlett-Packard, Chrysler and Xerox.

However, as Luecke points out, the lessons of history are limited, and the dangers of misinterpreting are great. If managerial leadership could be achieved merely by study and mastery of history, Yamamoto would have won the Battle of Midway, Johnson would have won the Vietnam War and New Coke would have won the cola wars. As Ecclesiastes notes, “the race is not

to the swift, nor the battle to the strong. . . but time and chance happened to them all.” Perfect timing and the openness to chance or rapid change are key notions in Luecke’s readable book. Because of time and chance, history is a limited tool in predicting the future, and thus *Scuttle Your Ships Before Advancing* is a limited tool in taking lessons in leadership, but an interesting one.

